

the Steam Zone™

Instruction Book - BFS800



Breville®



Contents

- 2 Breville recommends safety first
- 6 Components
- 8 Functions
- 12 Cooking Guides
- 14 Care & Cleaning

BREVILLE RECOMMENDS SAFETY FIRST

At Breville we are very safety conscious. We design and manufacture consumer products with the safety of you, our valued customer, foremost in mind. In addition we ask that you exercise a degree of care when using any electrical appliance and adhere to the following precautions.

IMPORTANT SAFEGUARDS

**READ ALL INSTRUCTIONS
BEFORE USE AND SAVE
FOR FUTURE REFERENCE**

- Remove any packaging material and promotional labels before using the food steamer for the first time.
- To eliminate a potential choking hazard for young children, remove and safely discard the protective cover first over the pins of the power plug when unpacking appliance for the first time.
- Do not place the food steamer near the edge of a table, counter or bench top during operation. Ensure that the surface is level, clean and free of water.
- Do not place this appliance on or near a hot gas or electric burner, or where it could touch a heated oven.
- Do not place any part of the food steamer in a gas, electric or microwave oven or on a hot gas or electric burner.
- Keep food steamer clear of walls, curtains and other heat or steam sensitive materials. Minimum 200mm distance.

- Do not use food steamer on metal surfaces, for example, a sink drain board.
- Always ensure the food steamer is properly assembled before use. Follow the instructions provided in this book.
- The appliance is not intended to be operated by means of an external timer or separate remote control system.
- Do not put any food or liquid other than water into the water tank in the steamer base. Only the steaming tray and the steam baskets are designed to cook food.
- Do not leave the appliance unattended when in use.
- Do not move the food steamer during operation.
- Avoid spillage over the power cord and power connector.
- Do not touch hot surfaces. Use the handles to remove the lid and steamer baskets.
- Take care to avoid contact with any steam escaping from the steam outlet holes on the steamer lid. Use dry oven mitts to protect hands.
- Always lift the lid away from you, when removing from steaming basket, to avoid steam escaping from under the lid. Carefully lift and remove the steaming baskets by the handles to avoid scalding from escaping steam. Use dry oven mitts to protect hands.
- Always ensure the food steamer is switched off at the power outlet and the power plug is removed from the power outlet before attempting to move the appliance, when the appliance is not in use and before cleaning or storing. Allow the steamer base and removable drip tray to cool before disassembling for cleaning and discarding liquid.

- Do not use harsh abrasives or caustic cleaners when cleaning this appliance.
- Keep the appliance clean. Follow the care and cleaning instructions provided in this book.

IMPORTANT SAFEGUARDS FOR ALL ELECTRICAL APPLIANCES

- Fully unwind the cord before use.
- Do not let the cord hang over the edge of a table or counter, touch hot surfaces or become knotted.
- To protect against electric shock, do not immerse the power cord, power plug or food steamer base in water or any other liquid.
- This appliance can be used by children aged from 8 years and above if they have been given supervision or instruction concerning use of the appliance in a safe way and understand the hazards involved.
- Cleaning and use maintenance shall not be made by children unless they are older than 8 years and supervised.
- Keep the appliance and its cord out of reach of children age younger than 8 years.
- This appliance is intended for household use only. Do not use this appliance for anything other than its intended use. Do not use in moving vehicles or boats. Do not use outdoors. Misuse may cause potential injury.

- It is recommended to regularly inspect the appliance. Do not use the appliance if power supply cord, plug or appliance becomes damaged in any way. Return the entire appliance to the nearest authorised Breville Service Centre for examination and/or repair.
- Any maintenance other than cleaning should be performed at an authorised Breville Service Centre.
- The installation of a residual current device (safety switch) is recommended to provide additional safety protection when using electrical appliances.
- It is advisable that a safety switch with a rated residual operating current not exceeding 30mA be installed in the electrical circuit supplying the appliance. See your electrician for professional advice.



CAUTION

Do not operate the food steamer on an inclined surface. Do not move the food steamer while it is operating.

**FOR HOUSEHOLD USE ONLY
SAVE THESE INSTRUCTIONS**



Components

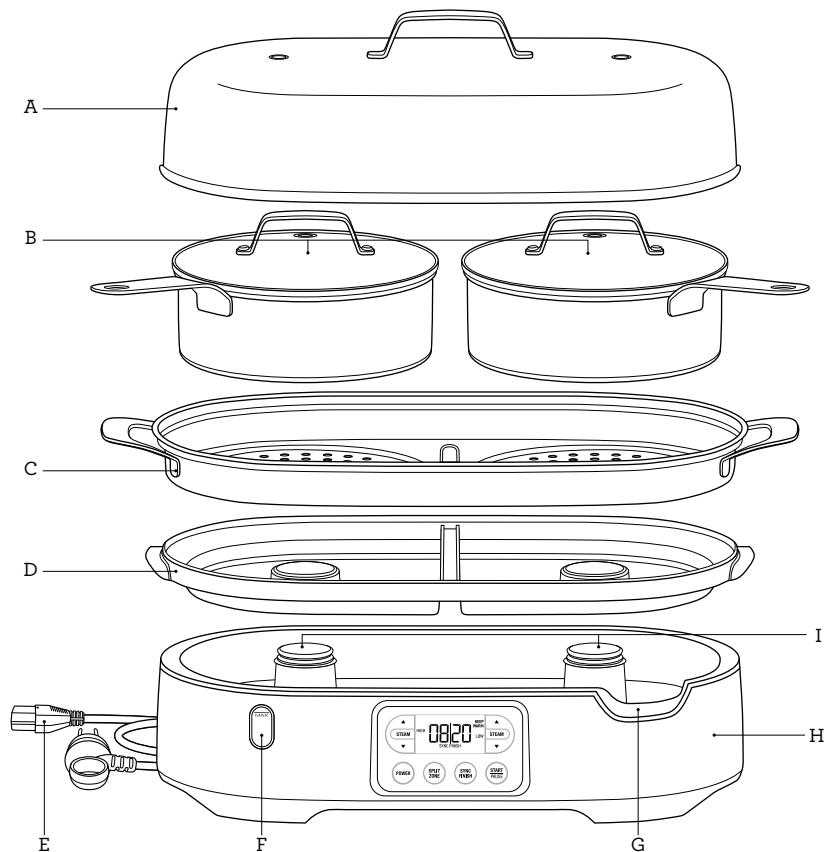

- A. Polished stainless steel steaming lid
- B. Stainless steel steaming baskets with glass steaming lids
Integrated dimples for holding eggs.
- C. Steaming tray
Cook large food directly on this tray.
- D. Drip tray
BPA free and dishwasher safe.
- E. Removable power cord
Detach for storage or to empty water tank.

- F. Water level window
Easy to check the amount of water in the tank.
- G. Water fill spout
Easy to add water during cooking and easy to empty the water tank.
- H. Steamer base with integrated water tank
(maximum capacity 1.8L)
- I. Steam nozzles

CONTROL PANEL

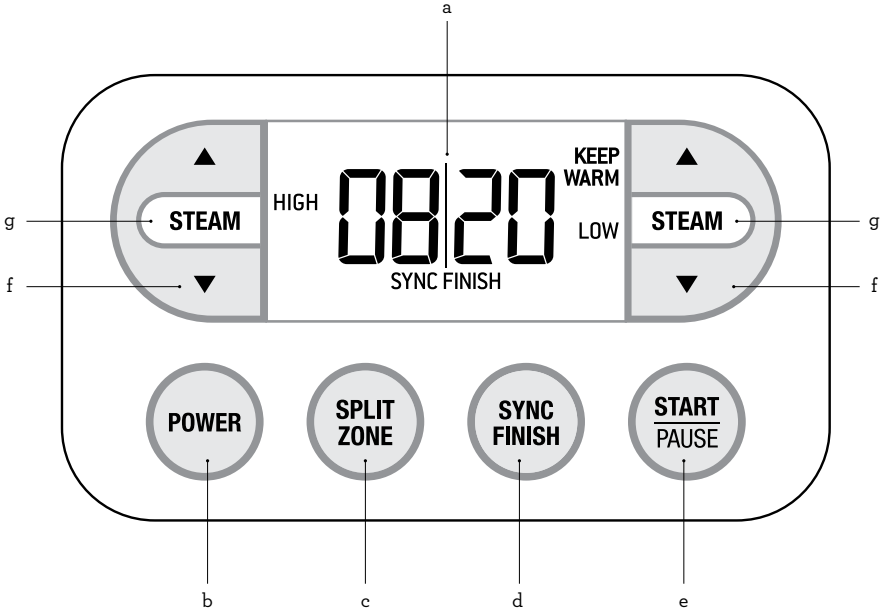

- a) **LCD screen**
Displays the selected steaming level, cooking time and settings.
- b) **POWER button**
- c) **SPLIT ZONE button**
Select SPLIT ZONE to allow independent time and steaming level to be set.
- d) **SYNC FINISH button**
Select SYNC FINISH to ensure food finishes cooking at the same time. SYNC FINISH is only available when SPLIT ZONE is selected.
- e) **START|PAUSE button**
- f) **TIMER button**
Sets cooking time in minutes. Displays seconds if time is less than one minute; displays minutes if time is greater than one minute.
- g) **STEAM button**
Select the steam cooking level, automatic keep warm or keep warm only.
- h) **RAPID START**
Designed to reach its maximum steaming level in less than 30 seconds. RAPID START will flash on the LCD screen while the steamer heats up.



Functions

BEFORE FIRST USE

Remove any packaging material and promotional labels from the food steamer.

Wash the steaming lids, steaming tray, steaming baskets, and drip tray in warm soapy water. Rinse and dry thoroughly. Wipe the inside of the water tank and the steaming nozzles with a damp cloth.

Setting water hardness

1. Ensure tank is filled with cold water.
2. Press POWER button to turn machine on.
3. The LCD will display 'Hrd5', prompting you to set the water hardness level. Programming this will determine the regularity of the 'DESCALE ME' alert which indicates when the steamer needs to be descaled.
4. Remove the supplied water hardness test strip from the wrapper.
5. Dip the test strip into a sample of the water you have filled the tank with so that all 5 squares are submerged for 1-3 seconds. Remove strip from water and wait for one minute. The water hardness setting is indicated by the number of red squares displayed on the test strip eg. 3 red squares indicates a water hardness setting of 3.
6. Press UP or DOWN arrow to the required setting from 'Hrd1' (softest water) to 'Hrd5' (hardest water). Press START button to set.
7. Your unit is now ready for use.

Checking/changing the water hardness level

1. With the unit in STANDBY, press and hold the SPLIT ZONE button then quickly press the POWER button.
2. The LCD will display your current water hardness setting.
3. Press UP or DOWN arrow to the required setting from 'Hrd1' (softest water) to 'Hrd5' (hardest water). Press START button to set.
4. Your unit is now ready for use.



WARNING

Do not immerse the power cord or steamer base in water or any other liquid.



SAFETY NOTE

- Close the stainless steel lid when you are cooking directly on the steaming tray.
- When using the steaming baskets, only close the basket lids. Never use the stainless steel lid when cooking in the steaming baskets.
- Do not touch the steaming lids during and after steaming. The lids can get very hot.
- If checking food during steaming, stop or pause steaming before removing the steaming lids.
- The captured steam in the steam zone is very hot. Always keep your face and hands away from the steamer when opening the steaming lids.
- Check the water level of the drip tray after each cycle of steaming. Empty water when needed.

HOW TO USE YOUR FOOD STEAMER

Using STEAM button

Press the STEAM button to select the steaming level and to automatically enable KEEP WARM mode when steaming ends.

SETTING	STEAM COOKING	KEEP WARM
HIGH	High steaming level for up to 45minutes.	No KEEP WARM mode after steaming ends.
LOW	Low steaming level for up to 45minutes.	No KEEP WARM mode after steaming ends.
KEEP WARM	Very low level of steam.	Programmable up to 45 minutes.
KEEP WARM HIGH	High steaming level for up to 45minutes.	When steaming ends, KEEP WARM mode will automatically turn on and run for up to 15 minutes. The KEEP WARM time is not programmable.
KEEP WARM LOW	Low steaming level for up to 45minutes.	

Quick start mode

Use the count-up timer to start steaming immediately in both combined and split zone modes.

1. Fill the water tank with clean tap water. Ensure the MAX level on the water window is not exceeded.
2. Place the drip tray and the steaming tray on the steamer base.
3. Place food on the steaming tray or in one or both of the steaming baskets.
4. Close the stainless steel lid when cooking directly on the steaming tray. When using the steaming baskets, only close the basket lids.
5. Press the POWER button.
6. Press the STEAM button on either side of the control panel to select the steaming level, steaming with automatic KEEP WARM or KEEP WARM only. See Using STEAM button section on this page.
7. Press the START | PAUSE button to start steaming. RAPID START will flash on the LCD screen while the steamer heats up.

8. The steaming level (HIGH/LOW) will flash when steam is being produced. The timer on the LCD screen will start counting up, indicating the elapsed cooking time.
9. You can steam up to 45 minutes in this steaming mode. Press the START | PAUSE button at any time to stop cooking. After 45 minutes the steamer will beep three times to indicate steaming is completed. If KEEP WARM was enabled, the steamer will automatically enter KEEP WARM mode for 15 minutes. When KEEP WARM is finished, the steamer will beep one time.

Combined zone steaming

Use the whole steam zone to cook foods directly on the steaming tray. With this setting, the LCD screen will display a single timer.

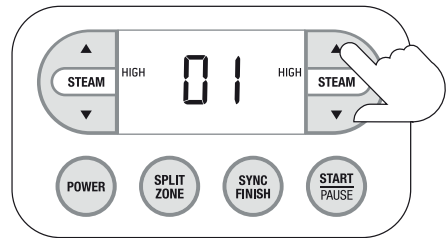

1. Fill the water tank with clean tap water. Ensure the MAX level on the water window is not exceeded.
2. Place the drip tray and the steaming tray on the steamer base.
3. Place the food on the steaming tray and close the stainless steel lid.
4. Press the POWER button.
5. Set the steaming time by pressing the up and down arrows on either side of the control panel. The steaming time can be set from 1-45 minutes.
6. Press the STEAM button on either side of the control panel to select the steaming level, steaming with automatic KEEP WARM or KEEP WARM only. See Using STEAM button section on this page.

- Press the START | PAUSE button to start steaming. RAPID START will flash on the LCD screen while the steamer heats up.
- The steaming level (HIGH/LOW) will flash when steam is being produced. The timer will start counting down.
- After the steaming time is finished, the steamer will beep three times. If KEEP WARM was enabled, the steamer will automatically enter KEEP WARM mode for 15 minutes. When KEEP WARM is finished, the steamer will beep one time.

Split zone steaming

The steaming area can be divided into two separate zones to cook foods that require different steaming level and cooking times. The LCD screen will display two separate timers.

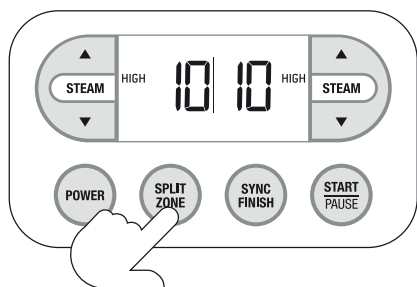

- Fill the water tank with clean tap water. Ensure the MAX level on the water window is not exceeded.
- Place the drip tray and the steaming tray on the steamer base.
- Place the food into one or both of the steaming baskets and close the basket lids.
- Press the POWER button.
- Press the SPLIT ZONE button. The LCD screen will display two steaming levels and two timers.
- Set the steaming time for each zone by pressing the up and down arrows on each side of the control panel. The steaming time can be set from 1-45 minutes.

- Press STEAM button on each zone to select steaming level, steaming with automatic KEEP WARM or KEEP WARM only. See page 9 Using STEAM button section.
- Press the START | PAUSE button to start steaming. RAPID START will flash on the LCD screen while the steamer heats up.
- The steaming level (HIGH/LOW) will flash when steam is being produced. The timer will start counting down.
- After the steaming time is finished for each zone, the steamer will beep three times. If KEEP WARM was enabled, the steamer will automatically enter KEEP WARM mode for 15 minutes. When KEEP WARM is finished, the steamer will beep one time.

Synchronised finish

If you have set different cooking times for split zone steaming, use the SYNC FINISH function to ensure your entire meal is ready at the same time. The synchronised finish function will automatically delay starting the zone with the shorter steaming time so that both zones finish steaming at the same time.

- Press the SPLIT ZONE button for split zone steaming.
- Press the SYNC FINISH button to enable synchronised finish mode.
- Set the steaming time for each zone and proceed as directed for split zone steaming.

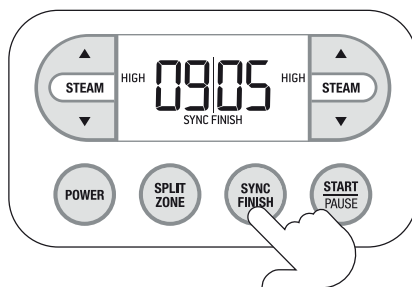

- Press the START|PAUSE button and the zone with the longer steaming time will start. The second zone will automatically start so that both zones finish steaming at the same time.
- After the steaming time is finished, the steamer will beep three times. If KEEP WARM was enabled, the steamer will automatically enter KEEP WARM mode for 15 minutes. When KEEP WARM is finished, the steamer will beep one time.

Pause cooking

You can stop/pause steaming in all steaming modes.

- During steaming, press the START|PAUSE button to pause the steaming. The LCD backlight will change from orange to white.
- When START is pressed to resume, RAPID START will flash on LCD for 10 seconds.

Adding water while cooking

You can add water at any time during cooking by pouring water into the water fill spout.

- If the water level gets low during steaming, the steamer will beep twice and FILL WATER will flash on the LCD screen. The steamer and timer will pause and the LCD backlight will change from orange to white. The steamer will continue to beep every 30 seconds until the water is refilled.
- Pour water into water fill spout.
- Once the water is refilled, the steamer will automatically restart.

Descaling

DESCALE ME will display on your LCD when it is time to perform the descale.



NOTE

If the DESCALE ME reminder is ignored, the unit will prevent any further cooking until a descale has been performed.

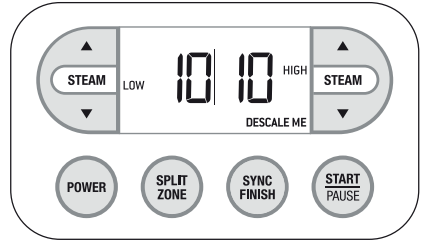

- Add 1 cup white vinegar and 3 cups clean tap water to the tank.
- Place the drip tray, steaming tray and stainless steel lid onto the steamer base.
- Turn on the unit by pressing the POWER button.
- Press and hold the START button for 5 seconds to activate the descale cycle.
- The descale cycle will take about 20 minutes; its progress will display on the LCD.
- When finished empty the drip tray and the water tank.
- Use a damp cloth or paper towel to remove any remaining scale from the edges of the steam nozzles.
- Add 2 cups clean tap water to the tank and run the steamer on HIGH for 5 minutes to purge any remaining descaling solution from the system.



Cooking Guides

Steaming times are a guide only. They may vary depending on personal preference. Please adjust times accordingly.

VEGETABLE	SIZE/PREPARATION	TIME
Bok Choy	Trimmed	3 minutes on HIGH
Broccoli	Cut into florets x 140gms	3 minutes on HIGH
Cauliflower	Cut into florets x 140gms	5 minutes on HIGH
Corn on the Cob	Cut into chunks	10 minutes on HIGH
Potatoes	40g each or quartered	25 minutes on HIGH
Medium carrots	Cut into chunks	10 minutes on HIGH
Dutch carrots	Whole	10 minutes on HIGH
Zucchini	Cut into chunks	5 minutes on HIGH
Beetroot	Small or cut into 40gr each	25 minutes on HIGH
Frozen Vegetables	Max 400gms in steaming basket	12 minutes on HIGH
Green beans	Trimmed	4 minutes on HIGH
Brussels sprouts	Trimmed	7 minutes on HIGH
Sweet potatoes	3cm thick/wedges	12 minutes on HIGH

For best results, cook vegetables in a single layer. Softer vegetables such as broccoli should be served immediately after steaming as they may lose colour and overcook in **KEEP WARM** mode.

RICE	PREPARATION	TIME
White long grain rice	1 cup rice/1¼ cup water	25 minutes on HIGH
Brown rice	1 cup rice/1 ¼ cup water	42 minutes on HIGH
Basmati rice	1 cup rice/1 ¼ cup water	22 minutes on HIGH
Jasmine rice	1 cup rice/1 ¼ cup water	22 minutes on HIGH
Sushi rice	1 cup rice/1 ¼ cup water	22 minutes on HIGH
Black rice	1 cup rice/1¼ cup water	30 minutes on HIGH

Place the rice and water in a heat-proof bowl. Make sure the bowl fits on the steaming tray or in the steaming basket with the stainless steel lid or basket lid properly closed.

60G EGGS FROM THE FRIDGE	PREPARATION	TIME
Soft	6 pricked eggs in steam basket, lid on	7 minutes on HIGH
Medium	6 pricked eggs in steam basket, lid on	9 minutes on HIGH
Hard	6 pricked eggs in steam basket, lid on	12 minutes on HIGH

Eggs are best served immediately after steaming as they will continue cooking if kept on **KEEP WARM**
Prick eggs with a pin before cooking to help prevent cracking.

FISH	PREPARATION	TIME
Frozen fish fillets x 230g	On greased tray	20 minutes on LOW*
Fresh fish fillets x 200g	On greased tray	12 minutes on LOW
Whole fresh fish x 500g	On greased tray	10 minutes on LOW
Whole fresh fish x 1.4kg	On greased tray	20 minutes on LOW

*Cooking time may vary depending on thickness of fish fillet.
For a thinner, frozen fillet steam for 9–12 minutes.

CHICKEN	PREPARATION	TIME
Chicken breast (150g) each	On greased tray	13 minutes on LOW
Whole chicken (1.6kg)	On greased tray	45 minutes on LOW

To check the chicken is thoroughly cooked insert a skewer into the thickest part of the meat, the juices should run clear. Alternatively if you are using a meat thermometer the food safe temperature is 75°C and above.



NOTE

Whole poultry can release a large volume of juices during steaming.
Monitor the drip tray and empty before it becomes too full.



Care & Cleaning

1. Unplug the power cord of the food steamer and allow the base, drip tray, steaming tray, steaming baskets, basket lids and stainless steel lid to cool down before disassembling and cleaning.
2. When completely cool, detach the power cord from the steamer base. Carefully discard the remaining liquid in the drip tray and water tank. Wipe the interior of the water tank with a damp cloth then dry thoroughly.
3. The drip tray, steaming tray, steaming baskets, basket lids, and stainless steel lid can either be washed in a dishwasher or using warm soapy water. Do not use abrasive cleaners, steel wool or scouring pads as these can damage the surface. Clean the food steamer after each use.

TO CLEAN THE EXTERIOR

The steamer base can be wiped with a damp cloth then dried thoroughly.

Do not use abrasive cleaners, steel wool or scouring pads as these can damage the surface of the food steamer.

Take extra care when cleaning the water level sensor. Scratches on the water level sensor may lead to malfunction.

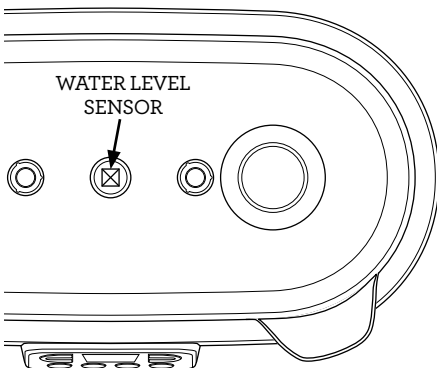

WARNING

Do not immerse steaming base, power cord or power plug in water or any other liquid as this may cause electrocution.

STORAGE

The steaming baskets and detachable cord can be placed inside the basket lids for storage.

Breville Customer Service Centre

Australian Customers

Mail: Locked Bag 2000
Botany NSW 1455
AUSTRALIA

Phone: 1300 139 798

Fax: (02) 9700 1342

Email: Customer Service:
askus@breville.com.au

Web: www.breville.com.au

New Zealand Customers

Mail: Private Bag 94411
Botany Manukau 2163
Auckland NEW ZEALAND

Phone: 0800 273 845

Fax: 0800 288 513

Email: Customer Service:
askus@breville.co.nz

Web: www.breville.co.nz

Breville®
Thought for food

Breville is a registered trademark of Breville Pty. Ltd. A.B.N. 98 000 092 928.
Copyright Breville Pty. Ltd. 2016.

Due to continued product improvement, the products illustrated/photographed
in this brochure may vary slightly from the actual product.