

CREATISTA PRO
MY MACHINE

Breville

NESPRESSO®

Nespresso Breville Creatista Pro

Congratulations on your purchase of the *Nespresso Breville Creatista Pro*, the machine that allows you to make cafe quality milk coffees.

Packaging Content



1 **Creatista Pro** Coffee Machine



2 **Tasting Box** of *Nespresso*
Capsules



3 **Milk** Jug



4 **Nespresso** Welcome Brochure

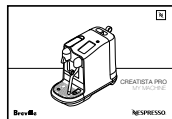

5 **User** Manual



6 **1 x Water Hardness** Test Strip, in the User Manual

Creatista Pro

EN

USER MANUAL

Nespresso is an exclusive system creating the perfect Espresso, time after time. Each parameter has been calculated with great precision to ensure that all the aromas from each capsule can be extracted, to give the coffee body and create an exceptionally thick and smooth crema.

BNE900 Specifications

~ 220–240 V, 50–60 Hz, 2300 W

P_{max} 19 bar / 1.9 MPa

kg ~6.65 kg / 14.7 lbs

📄 2 L / 68 fl.oz

📦 25.1 cm 41.8 cm 49.9 cm
9.8 in 16.5 in 19.6 in

Contents

<i>Safety Precautions</i>	4
<i>Machine Overview</i>	7
<i>First Use</i>	8
<i>Drinks Menu</i>	9
<i>Coffee Settings</i>	9
<i>Milk Coffee</i>	11
<i>Regular Coffee</i>	12
<i>Coffee Preparation Tips</i>	13
<i>Daily Cleaning</i>	14
<i>Maintenance</i>	15
<i>Descaling</i>	16
<i>Water Hardness</i>	16
<i>Trouble Shooting</i>	17
<i>Contact Nespresso</i>	19
<i>Disposal and Environmental Protection</i>	19
<i>Limited Guarantee</i>	19

Safety Precautions



⚠ CAUTION: the safety precautions are part of the appliance. Read them carefully before using your new appliance for the first time. Keep them in a place where you can find and refer to them later on.

⚠ CAUTION: when you see this sign, please refer to the safety precautions to avoid possible harm and damage.

ℹ INFORMATION: when you see this sign, please take note of the advice for the correct and safe usage of your appliance.

⚡ WARNING: When you see this sign, follow the instructions to avoid electrical risks that could result in injury.

🔌 If the cord is damaged, do not operate the appliance.

The appliance is intended to prepare beverages according to these instructions.

- Do not use the appliance for anything other than its intended use.
- Do not operate the appliance if it is in an enclosed space, or within a cupboard.
- This appliance has been designed for indoor and non-extreme temperature conditions use only.
- Protect the appliance from direct sunlight effect, prolonged water splash and humidity.
- This is a household appliance only. It is not intended to be used in: staff kitchen areas in shops, offices and other working environments; farm houses; by clients in hotels, motels and other residential type environments; bed and breakfast type environments.
- This appliance may be used by children of at least 8 years of age, as long as they are supervised and have been given instructions about using the appliance safely and are fully aware of the dangers involved. Cleaning and user maintenance shall not be made by children unless they are older than 8 and they are supervised by an adult.
- Keep the appliance and its cord out of reach of children under 8 years of age.
- This appliance may be used by persons with reduced physical, sensory or mental capabilities, or whose experience or knowledge is not sufficient, provided they are supervised or have received instruction to use the appliance safely and understand the dangers.

- Children shall not use the device as a toy.
- The manufacturer accepts no responsibility and the warranty will not apply for any commercial use, inappropriate handling or use of the appliance, any damage resulting from use for other purposes, faulty operation, non-professionals repair or failure to comply with the instructions.

⚡ Avoid risk of fatal electric shock and fire.

- In case of an emergency: immediately remove the plug from the power socket.
- Only plug the appliance into suitable, easily accessible, earthed mains connections. Make sure that the voltage of the power source is the same as that specified on the rating plate. The use of an incorrect connection voids the warranty.

The appliance must only be connected after installation.

- Do not pull the cord over sharp edges, clamp it or allow it to hang down.
- Keep the cord away from heat and damp.
-  If the supply cord is damaged, it must be replaced by the manufacturer, its service agent or similarly qualified persons, in order to avoid all risks.
- If the cord is damaged, do not operate the appliance; return the appliance to *Nespresso* or to a *Nespresso* authorised representative.
- If an extension cord is required, use only an earthed cord with a conductor cross-section of at least 1.5 mm² or

matching input power.

- To avoid hazardous damage, never place the appliance on or beside hot surfaces such as radiators, stoves, ovens, gas burners, open flame, or similar.
- Always place it on a horizontal, stable and even surface. The surface must be resistant to heat and fluids, like water, coffee, descaler or similar liquids.
- Disconnect the appliance from the mains when not in use for a long period. Disconnect by pulling out the plug and not by pulling the cord itself or the cord may become damaged.
- Before cleaning and servicing, remove the plug from the mains socket and let the appliance cool down.
- Never touch the cord with

wet hands.

- Never immerse the appliance or part of it in water or other liquid.
- Never put the appliance or part of it in a dishwasher.
- Electricity and water together is dangerous and can lead to fatal electrical shocks.
- Do not open the appliance. Hazardous voltage inside!
- Do not put anything into any openings. Doing so may cause fire or electrical shock!

Avoid possible harm when operating the appliance.

- If coffee volumes are programmed higher than 150ml (5 oz); allow the machine cool down for 5 minutes before making next coffee to prevent risk of overheating!
- Never leave the appliance

unattended during operation.

- Do not use the appliance if it is damaged or not operating perfectly. Immediately remove the plug from the power socket. Contact *Nespresso* or *Nespresso* authorised representative for examination, repair or adjustment.
-  **A damaged appliance can cause electrical shocks, burns and fire.**
- Always completely close the handle and never open it during operation. Scalding may occur.
- Do not put fingers under coffee outlet, risk of scalding.
- Do not put fingers into capsule compartment or the capsule shaft. Danger of injury!
- Do not touch the capsule compartment just after

- brewing due to risk of scalding. Water could flow around a capsule when not perforated by the blades and damage the appliance.
- Never use a damaged or deformed capsule. If a capsule is blocked in the capsule compartment, turn the machine off and unplug it before any operation. Call *Nespresso* or *Nespresso* authorised representative.
 - Misuse may result in injury.
 - Fill the water tank only with fresh and potable water.
 - Empty water tank if the appliance will not be used for an extended time (holidays, etc.).
 - Replace water in water tank when the appliance is not operated for a weekend or a similar period of time.
 - Do not use the appliance without the drip tray and drip grid to avoid spilling any liquid on surrounding surfaces.
 - Do not use any strong cleaning agent or solvent cleaner. Use a damp cloth and mild cleaning agent to clean the surface of the appliance.
 - To clean machine, use only clean cleaning tools.
 - Do not use abrasive material that might damage the surface of the equipment.
 - When unpacking the machine, remove the plastic film and dispose.
 - This appliance is designed for *Nespresso* coffee capsules available exclusively through *Nespresso* or your *Nespresso* authorised representative.
 - This equipment is specific for cow milk, not to use with other products/alternative milk (soya milk, oat milk, almond milk), therefore it is not fit for lactose intolerants or milk allergics.
 - All *Nespresso* appliances pass stringent controls. Reliability tests under practical conditions are performed randomly on selected units. This can show traces of any previous use.
 - *Nespresso* reserves the right to change instructions without prior notice.
 - This machine contains magnets.
- Descaling**
- *Nespresso* descaling agent, when used correctly, helps ensure the proper functioning of your machine over its lifetime and that your coffee experience is as perfect as the first day.
- SAVE THESE INSTRUCTIONS**
Pass them on to any subsequent user.
This instruction manual is also available as a PDF at nespresso.com

Machine Overview

Power button

LCD touch screen

Lever for capsule insertion

Capsule container

Pop out cup support

Removable drip grid

Drip tray baffle

Removable drip tray with full indicator

Easy clean steam wand

Milk jug temperature sensor

Milk jug

Power button
Press to turn machine ON / OFF

LCD touch screen
- Swipe to navigate
- Tap to select

Water tank & lid

Removable pin cleaning tool

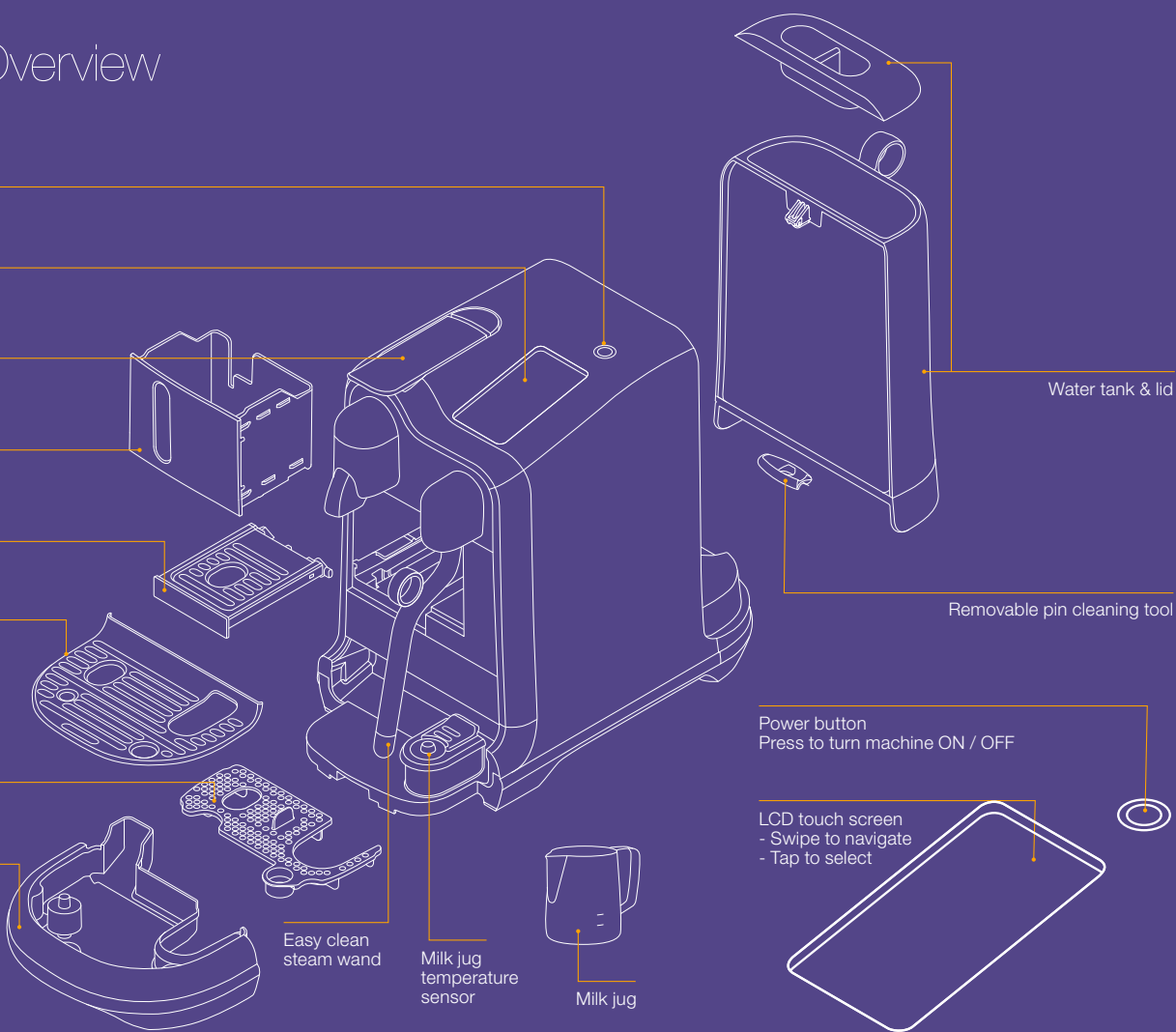

First Use

i Read and safely discard any packaging materials or promotional labels attached to your machine before use.

i Read the important safeguards first to avoid risks of fatal electrical shock and fire.

⚠ **CAUTION:** Please ensure ground continuity when plugging the machine in the power outlet.

1 Plug the machine into the power outlet.

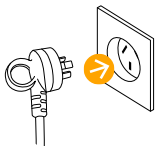

2 Turn the machine ON by pressing the Power button.

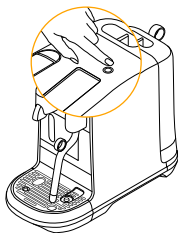

3 Tap to select your language.



4 Follow on-screen instructions for machine set up.

First use cycle is to rinse the machine and prime the heating system.



5 Follow the on-screen Quick Start Guide.

Water Hardness can be manually set or the default can be used. The setting can be adjusted in the menu.



6 To turn OFF your machine, press the Power button. Any drink recipe can be interrupted by turning the machine off.

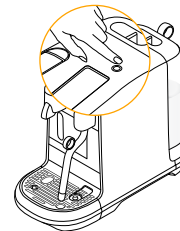

EN Drinks Menu & Selection

Drink Menu



Hot Water

Tap to manually start and stop.
Max. 200 mls
(6.5 fl. oz)

Swipe up and down
on the touch screen
to navigate the menu.

Tap the screen
to select.

Drink Confirmation

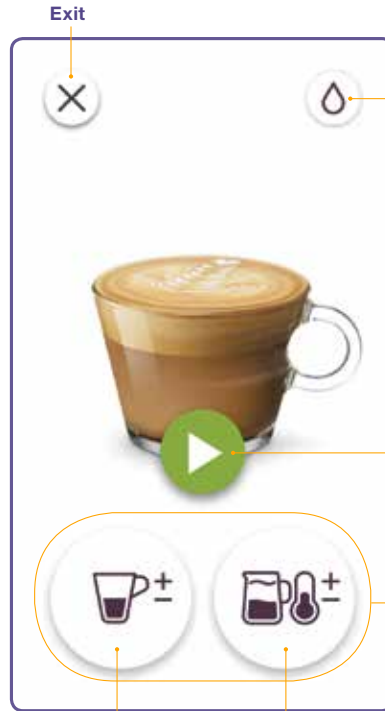

Exit

Hot Water

Tap to Start

Drink Adjustments

Coffee
Settings

Milk
Settings

Drink Adjustments

Adjust Coffee Volume

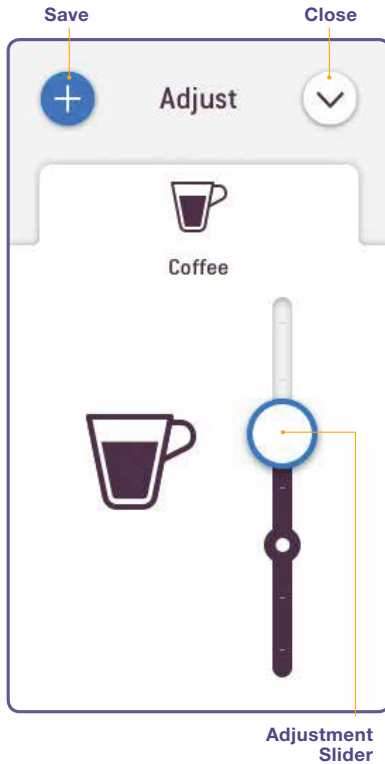

Adjust Milk Froth Level

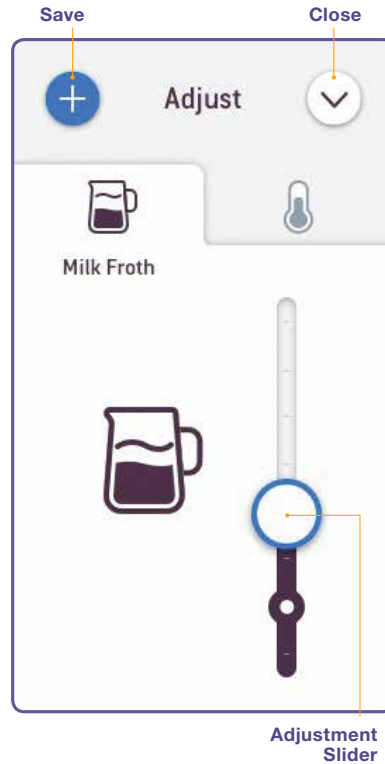

Adjust Milk Temperature

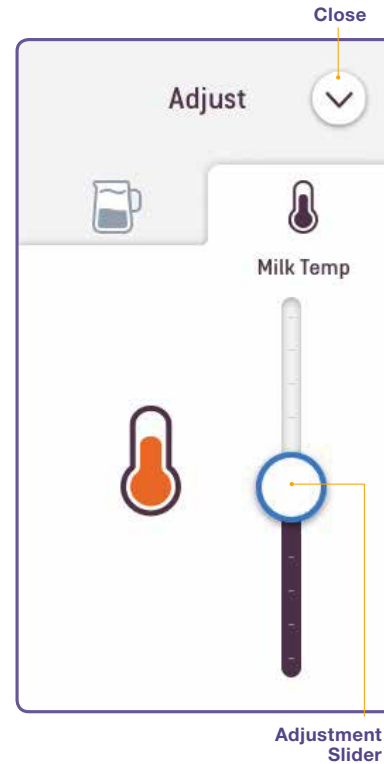

- 1 Slide circle up and down the bar to adjust. Notch on the bar is the drink default setting.
- 2 Tap + to save your custom drink settings. Custom drink will appear in Drinks Menu.

EN Making a Milk Coffee

Drink Running



Coffee extraction and milk texturing will start simultaneously.

Coffee and milk will stop running automatically. Alternatively, tap the icon to stop.

Coffee Running

Milk Running

Drink Complete



Hot Water
Tap to manually start and stop.

Add Coffee
(insert new capsule and extract again)

Milk Complete

Icons



Next



Back



Close



Skip



Update Save



Menu



Information



Save



Delete



Waiting

Making a Regular Coffee

Drink Confirmation



Coffee Settings

Drink Running



Coffee Running

Drink Complete



Add Coffee
(insert new capsule and extract again)

Coffee will stop running automatically. Alternatively, tap the icon to stop.

EN Coffee Preparation Tips

i To ensure **hygienic conditions**, it is highly recommended not to reuse a used capsule.

i For **optimal milk froth**, use pasteurised whole or semi skimmed milk at refrigerated temperature (about 4-6 °C / 39-43 °F).



For smaller cups, use the cup support.

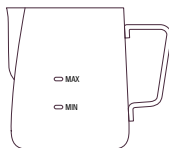

Only use the milk jug provided for texturing milk.

⚠ CAUTION: Do not fill milk jug above the maximum level marked on the inside & outside of the jug.

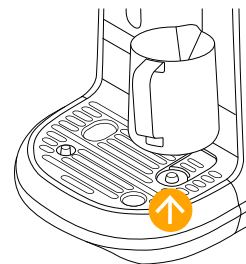

Always ensure the milk jug is positioned on the drip tray temperature sensor when texturing milk.

Adjusting Regular / Milk Coffee Drinks

Regular Coffee	Coffee Volume	Milk Coffee	Settings
Ristretto	From 10 to 30 ml / 0.35 - 1 fl. oz	Coffee Volume	7 levels from 15 to 130 ml / 0.5 - 4.4 fl. oz
Espresso	From 30 to 70 ml / 1 - 2.3 fl. oz	Hot Water Volume	7 levels from 50 to 200 ml / 1.7 - 6.8 fl.oz
Lungo	From 70 to 130 ml / 2.3 - 4.4 fl. oz	Milk Temperature	11 levels from 50° to 76°C / 122° to 169°F
		Milk Froth	8 levels from 2 to 30mm

Milk Levels

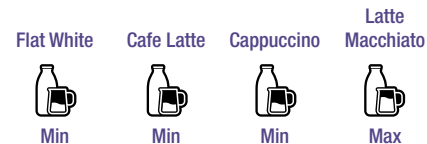

Daily Cleaning

i **Do not use** any strong or abrasive solvent, sponges or cream cleaners when cleaning. Do not put any parts in the dishwasher.

i **Never immerse** the appliance or any part of it in water or any other liquid

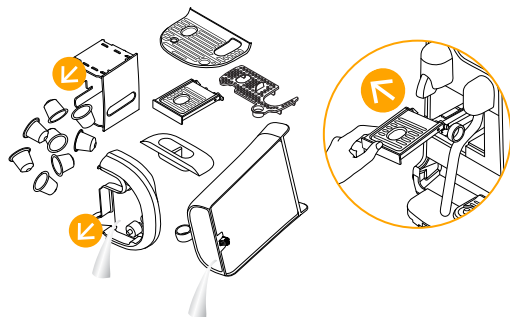

1 Empty the drip tray and capsule container every day.
Remove and clean the cup support and wipe inside the machine. Remove and clean the water tank with an odorless detergent and rinse with warm water.

2 Rinse and dry the milk jug after each use. If required, use a mild detergent.

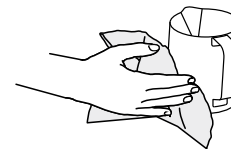

3 Fill the milk jug with fresh potable water to the MAX level. Position the steam wand in the centre of the milk jug and ensure the milk jug is positioned on top of the sensor in the drip tray.

 **Select Rinse Steam Wand** in the Menu. Once complete, discard the water and wipe the steam wand with a clean, damp cloth.

4 Dry all parts with a soft clean cloth and reassemble machine. Wipe coffee outlet and machine regularly with a clean damp cloth.

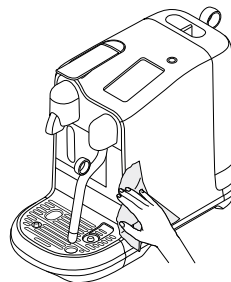

Tap to select and follow the on-screen instructions.



Clean Steam Wand

Recommended monthly to clean steam paths, steam wand and prevent blockages.



Rinse Steam Wand

Use daily to clean any blockages.



Descal

Remove any scale build-up. Refer to Descal instructions on following page.



Water Hardness

Reset the water hardness level.



Rinse Cycle

When machine hasn't been used for an extended period of time.



Empty Cycle

When storing machine for a period of non-use or for frost protection.



Quick Start Guide

See the Quick Start guide again.



Language

Change the language of the machine.



Factory Reset

Erases all settings and returns unit to factory settings.

Descaling



Duration approximately 15 minutes.



Read the important safeguard on the descaling package and refer to the table for the frequency of use. The descaling solution can be harmful. Avoid contact with eyes, skin and surfaces. Never use any product other than the *Nespresso* descaling kit available at *Nespresso* to avoid damage to your machine. The following table will indicate the descaling frequency required for the optimum performance of your machine, based on water hardness. For any additional questions you may have regarding descaling, please contact *Nespresso*.

Descaling: Removes scale build-up, maintains coffee taste and prevents machine damage. Frequency will depend on your water hardness and amount of use. Descale when prompted on-screen. The machine will stop you from use if the descale cycle has not been performed after 30 uses. A "lockout" count-down will appear to alert you of the number of uses remaining until usage will stop.



Navigate to the Menu

and select Descale. Follow the on-screen instructions.

Water Hardness Levels

Water hardness:			Descaling after:		
	App.	fH	dH	CaCO ₃	(40 ml)
	Level 0	< 5	< 3	< 50 mg/l	2 200
	Level 1	> 7	> 4	> 70 mg/l	1 800
	Level 2	> 13	> 7	> 130 mg/l	1 400
	Level 3	> 25	> 14	> 250 mg/l	1 000
	Level 4	> 38	> 21	> 380 mg/l	600

fH French degree
dH German Grade
CaCO₃ Calcium Carbonate

Screen / buttons not illuminated.	<ul style="list-style-type: none"> - Machine turns OFF automatically. - Press POWER button to turn machine ON. 	<ul style="list-style-type: none"> - Check the outlet: plug, voltage, fuse.
No steam or hot water.	<ul style="list-style-type: none"> - Machine is OFF. Press POWER button to turn machine ON. 	<ul style="list-style-type: none"> - Check the outlet: plug, voltage, fuse.
No coffee, no water, unusual coffee flow.	<ul style="list-style-type: none"> - Check if the water tank is correctly positioned, if empty, fill with fresh, potable water. 	<ul style="list-style-type: none"> - Descale the machine, if necessary.
Coffee is not hot enough.	<ul style="list-style-type: none"> - Preheat cup using hot water button. 	<ul style="list-style-type: none"> - Descale the machine, if necessary.
The capsule lever does not close completely.	<ul style="list-style-type: none"> - Empty the capsule container. 	<ul style="list-style-type: none"> - Check that capsules aren't blocking inside the machine. (Note: do not place fingers inside the machine)
Leakage (water under the machine).	<ul style="list-style-type: none"> - Empty drip tray if full. - Check drip tray is securely inserted. 	<ul style="list-style-type: none"> - If problem persists, call Nespresso.
No coffee flow, water goes directly into the capsule bucket (despite inserted capsule).	<ul style="list-style-type: none"> - Ensure capsule lever is closed. 	<ul style="list-style-type: none"> - Empty capsule bucket and check that no capsule is blocked inside the machine. (NOTE: do not place fingers inside the machine) - If problem persists, call the Nespresso.
Display is dim and hard to see/read.	<ul style="list-style-type: none"> - Screen brightness is set on a low setting. - Press POWER button to turn ON. 	<ul style="list-style-type: none"> - Adjust the screen brightness setting. Navigate to Menu and select Screen Brightness.
Fill Water Tank prompt remains on screen (water tank is full).	<ul style="list-style-type: none"> - Check if the water tank is correctly positioned. 	<ul style="list-style-type: none"> - If problem persists, call Nespresso.
Descal alert is displayed.	<ul style="list-style-type: none"> - Descale the machine. 	<ul style="list-style-type: none"> - Navigate to the Menu and select Descal. Follow on-screen prompts.
Machine is ON but ceases to operate.	<ul style="list-style-type: none"> - Press POWER button to turn machine OFF. - Wait 60 minutes and press POWER button to turn machine ON. 	<ul style="list-style-type: none"> - If problem persists, call Nespresso.
Touchscreen is not working.	<ul style="list-style-type: none"> - Press POWER button to turn machine OFF. Press POWER button again to turn machine ON. 	<ul style="list-style-type: none"> - If problem persists, call Nespresso.

Troubleshooting Milk Froth Preparation

Milk steam cycle does not start.	<ul style="list-style-type: none">- Check if the water tank is correctly positioned, if empty, fill with fresh potable water.- Check steam tip for any blockages and ensure wand is lowered.	
Quality of froth not up to standard.	<ul style="list-style-type: none">- Be sure to use pasteurised whole or semi-skimmed milk at refrigerated temperature (about 4-6 °C / 39-43° F). For a better result, the milk should be newly opened.- Check the milk froth setting.	<ul style="list-style-type: none">- Use the provided milk jug.- Clean both the milk jug and steam wand after each use.- Complete Steam Wand Cleaning Cycle. Navigate to the Menu and select Clean Steam Wand, follow the on-screen prompts.
Steam is very wet.	<ul style="list-style-type: none">- Use fresh, potable water.- Do not use highly filtered, demineralised or distilled water.	
Milk overflows.	<ul style="list-style-type: none">- Fill jug with appropriate milk volume. DO NOT fill above the MAX level.- Minimum and maximum levels are marked on the inside and outside of the jug.	<ul style="list-style-type: none">- To stop overflow, either reduce the initial volume of milk and/or reduce the froth level. This varies depending on milk type.
Milk temperature is too hot.	<ul style="list-style-type: none">- Use the milk jug provided.- Check the milk jug is positioned correctly on the milk jug temperature sensor in the drip tray.- Check the temperature sensor in the drip tray is dry and clean.	<ul style="list-style-type: none">- Decrease the milk temperature setting
Milk temperature is not hot enough.	<ul style="list-style-type: none">- Preheat cup.- Use the provided milk jug.- Check the milk jug is positioned on the temperature sensor in the drip tray.	<ul style="list-style-type: none">- Increase the milk temperature setting.- Check the steam tip for blockages.
Clean Steam Wand alert is displayed.	<ul style="list-style-type: none">- Clean the steam wand.	<ul style="list-style-type: none">- Navigate to the Menu and select Clean Steam Wand. Follow the on-screen prompts.

As we may not have foreseen all uses of your appliance, should you need any additional information, in case of problems or simply to seek advice, call *Nespresso* or your *Nespresso* authorized representative. Contact details for *Nespresso* or your *Nespresso* authorized representative can be found in the «Welcome to *Nespresso*» folder in your machine box or at nespresso.com

Your appliance contains valuable materials that can be recovered or can be recyclable. Separation of the remaining waste materials into different types facilitates the recycling of valuable raw materials. Leave the appliance at a collection point. You can obtain information on disposal from your local authorities.

Limited Guarantee

Breville guarantees this product against defects in materials and workmanship for two years domestic use (or 3 months commercial use) from the date of purchase. During this period, Breville will either repair or replace, at its discretion, any defective product at no charge to the consumer. In the event of a product or accessory being repaired or replaced during the guarantee period, the guarantee on the repaired product will expire two years from the purchase date of the original product, not two years from the date of repair. This guarantee excludes liability for consequential loss or any other loss or damage caused to property or person arising from any cause whatsoever. It also excludes defects caused by the product not being used in accordance with instructions, accidental damage, misuse, being tampered with by unauthorised persons, improper maintenance, consumable items or normal wear and tear and does not cover the cost of claiming under the warranty.

In Australia, our goods come with guarantees that cannot be excluded under the Australian Consumer Law. You are entitled to a replacement or refund for a major failure and for compensation for any other reasonably foreseeable loss or damage. You are also entitled to have the goods repaired or replaced if the goods fail to be of acceptable quality and the failure does not amount to a major failure.

How to Claim Under the Breville Warranty

Nespresso is handling product enquiries and product servicing on Breville's behalf. If you believe your product is defective, contact the *Nespresso* customer service team directly for instructions on where to send or bring it for repair by a Breville authorised service agent. Contact *Nespresso* **Australia:** 1800 623 033 or

New Zealand: 0800 234 579 nespresso.com.

This product is imported and distributed by Breville and this warranty is provided by Breville. To the extent permitted by law, *Nespresso* has no liability for the product and all guarantees, warranties and conditions by *Nespresso* are excluded.

Breville



CREATISTA PRO
by *Nespresso*