

the Smart Air Plus™

Instruction Book - LAP500



Breville®



Contents

- 2 Breville Recommends Safety First
- 6 Components
- 7 Control Panel
- 8 Features
- 8 Assembly
- 9 Functions
- 10 Care, Cleaning & Storage
- 12 Troubleshooting

BREVILLE RECOMMENDS SAFETY FIRST

At Breville we are very safety conscious. We design and manufacture consumer products with the safety of you, our valued customer, foremost in mind. In addition, we ask that you exercise a degree of care and adhere to the following precautions.

SPECIFICATIONS

Filter Life	Approx. 6 months
Microbe Shield™ Life	Approx. 10,000 hours
Product Dimension	270 x 531.5mm
For Room Size	40 to 50m ²
Noise Level	30-62dB
Power Consumption	65W
Weight	5kg

IMPORTANT SAFEGUARDS

READ ALL INSTRUCTIONS BEFORE USE AND SAVE FOR FUTURE REFERENCE

- Remove and safely discard any packaging material and promotional labels before using the air purifier and filter for the first time.
- To eliminate a choking hazard for young children, remove and safely discard the protective cover fitted to the power plug of this air purifier.
- When unpacking the air purifier, check to see you have received all the items listed in the parts list, before discarding the packaging.
- This air purifier is intended for household use only and not for commercial or industrial use.
- Do not use outdoors.
- Always ensure the air purifier is properly assembled before use. Follow the instructions provided in this book.
- Do not place the air purifier near the edge of a bench or table during operation. Ensure the surface is level, clean and free of water.

- Keep the power cord out of heavy traffic areas. To avoid fire hazard, never put the power cord under rugs, near heat registers, radiator, stoves or heaters.
- To protect against electrical hazards, do not immerse in water or other liquids. Do not use the air purifier in the immediate surroundings of a bath, a shower or a swimming pool.
- Children should be supervised to ensure they do not play with the air purifier.
- Always turn off and unplug the air purifier before moving, opening the grill, changing filters and cleaning or whenever the air purifier is not in use.
- Do not unplug the air purifier by pulling on the power cord. Always unplug using the power plug.
- Never insert fingers, pencils or any other objects through the guards whenever the power plug is connected, in particular, while the air purifier is switched on.
- Do not run the power cord under carpeting or cover the power cord with rugs, runners or the like. Arrange the power cord away from traffic areas and where it will not be tripped over.
- Do not route power cord under furniture or appliances.
- Do not operate the air purifier with a damaged power cord or plug, or if the air purifier has been dropped or damaged in any manner, return the air purifier to your nearest Breville service centre for examination, electrical or mechanical adjustment or repair.
- Do not use the air purifier with an external timer, programmer or any other device that switches the air purifier on automatically since a fire risk may exist if the air purifier is covered or positioned incorrectly.
- Do not place anything on top of air purifier when assembled, when in use and when stored.
- Never block the air openings, grills/outlets or place on a soft surface such as a bed or sofa, as this could cause the unit to tip over, blocking the air inlet or outlet opening.

- Do not attempt to repair or adjust any electrical or mechanical functions on this unit. Doing so will void your warranty. The inside of the unit contains no user serviceable parts. All servicing should be performed by qualified personnel only.
- This air purifier contains a UV-C emitter.
- Unintended use of the appliance or damage to the housing may result in the escape of dangerous UV-C light radiation. UV-C light radiation may, even in little doses, cause harm to the eyes and skin.
- Keep the air purifier and dust filters clean. Follow the cleaning instructions provided in this book.
- Do not let the power cord hang over the edge of a bench or table, touch hot surfaces or become knotted.
- To protect against electric shock, do not immerse the power cord, power plug or appliance in water or any other liquid or allow moisture to come in contact with the part, unless it is recommended in the cleaning instructions.
- The appliance is not intended for use by persons (including children) with reduced physical, sensory or mental capabilities, or lack of experience and knowledge, unless they have been given supervision or instruction concerning use of the appliance by a person responsible for their safety.
- Children should be supervised to ensure that they do not play with the appliance.
- It is recommended to regularly inspect the appliance. To avoid a hazard, do not use the appliance if power cord, power plug or appliance becomes damaged in any way. Return the entire appliance to the nearest authorized Breville Service Centre for examination and/or repair.

IMPORTANT SAFEGUARDS FOR ALL ELECTRICAL APPLIANCES

- Fully unwind the power cord before use.
- Connect only to a 230V or 240V power outlet.

- Any maintenance other than cleaning should be performed at an authorised Breville Service Centre.

- This appliance is for household use only. Do not use this appliance for anything other than its intended use. Do not use in moving vehicles or boats. Do not use outdoors.

Misuse may cause injury.

- The installation of a residual current device (safety switch) is recommended to provide additional safety protection when using electrical appliances. It is advisable that a safety switch with a rated residual operating current not exceeding 30mA be installed in the electrical circuit supplying the appliance. See your electrician for professional advice.
- During electrical storms, the appliance should be disconnected from the power source at the wall socket to prevent any electrical surges

that may arise during the storm and which may inadvertently cause damage to the appliance and its electronic componentry.

- Always turn the appliance to the off position, switch off at the power outlet and unplug at the power outlet when the appliance is not in use.
- Before cleaning, always turn the appliance to the off position, switch off at the power outlet, unplug at the power outlet and remove the power cord, if detachable, from the appliance and allow all parts to cool.
- Do not place this appliance on or near a heat source, such as hot plate, oven or heaters.
- Position the appliance at a minimum distance of 20cm away from walls, curtains and other heat or steam sensitive materials and provide adequate space above and on all sides for air circulation.

**FOR HOUSEHOLD USE ONLY
SAVE THESE INSTRUCTIONS**



Components

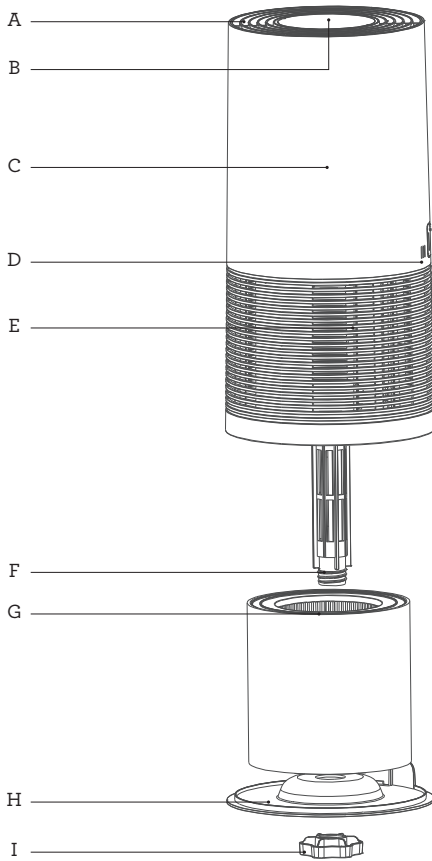

- | | |
|-------------------------------------|---------------------|
| A. Air Outlet | G. 3-Layer Filter |
| B. Control Panel | H. Base Plate |
| C. Main Housing Body | I. Locking Knob |
| D. Air Quality Sensor | |
| E. Air Inlet | NOT PICTURED |
| F. Microbe Shield™ Light and Holder | Power Cord |
| | Mesh Filter |



Control Panel

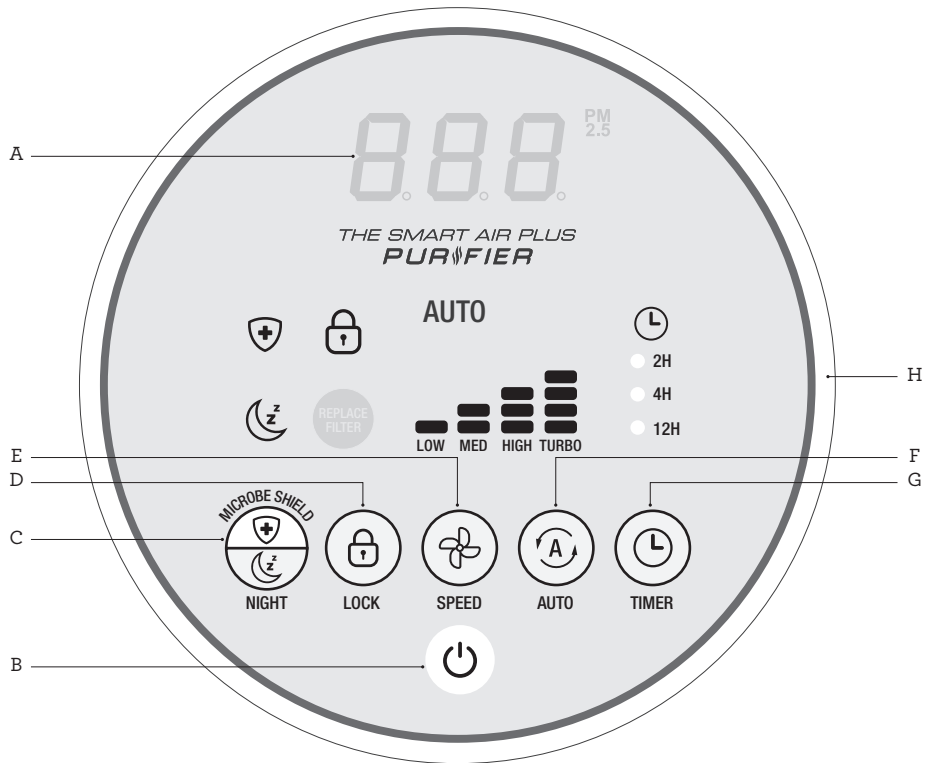

- A. LED Screen
- B. Power On/Off and Filter Reset Button
- C. Microbe Shield™/Night Mode
- D. Child Lock
- E. Fan Speed
(includes 4 speed modes; Low, Medium, High and Turbo)
- F. Auto Mode
- G. Timer
(up to 12 hours)
- H. Air Quality Sensor Light

The Breville Smart Air Plus™ Purifier has a visible air quality sensor light around the control panel. The light illuminates to indicate the quality of the surrounding air according to the table following:

Grade	Air Quality	AQI* Measured in PM2.5	Colour of Light
1	Very Good	< 33	Blue
2	Good	34-66	Yellow
3	Fair	67-99	Orange
4	Poor	> 100	Red

* Air Quality Index.



Features

YOUR BREVILLE AIR PURIFIER

Your Breville Smart Air Plus™ Purifier improves your indoor air quality using 4 distinct levels of protection.

- 1. A Pre-Filter**
Captures larger airborne particles such as human hair, pet dander and dust particles.
- 2. A True HEPA Filter**
Traps up to 99.97% of allergens and airborne contaminants down to 0.3 microns in size. These include dust, mould spores, plant spores, and pollen.
- 3. An Activated Carbon Membrane**
Along with assisting in the capture of dust, smoke, pollen and other airborne allergens, the activated carbon membrane helps to neutralise odours in the home and to eliminate fumes emitted by household products as well as other volatile organic compounds (VOC's) that might be found in the air.
- 4. Microbe Shield™ Technology**
Microbe Shield technology uses a shortwave UV-C light specially designed to target germs and bacteria from the incoming air as it passes through the air purifier before releasing the air back into the surrounding area. The Microbe Shield™ function can be turned on and off according to preference.



Assembly

BEFORE FIRST USE

- Remove and safely discard any packaging material or promotional labels attached to your air purifier and filter.
- Remove the filter from the air purifier (see REPLACING THE FILTER on page 11) and take it out of the plastic bag. Then re-insert the filter into the air purifier.
- Select a flat and level location for the air purifier.
- For proper air flow, locate the unit at least 20cm from any wall or furniture.
- Ensure the air inlet and outlets are not blocked before use.
- Ensure the filter has been fitted correctly as per the instructions in this book.
- Plug the power plug into a 230V OR 240V power outlet and turn on the power outlet.



IMPORTANT

When moving the air purifier, always lift the unit using two hands and set down gently on a flat and level surface.



Functions

OPERATING YOUR AIR PURIFIER

1. Press the  POWER button to turn on and the control panel will illuminate.
2. The air quality sensor light will illuminate, usually starting with a blue light until it has time to sense the air quality and then it may change to an alternate colour.
3. The air purifier will begin operation in the last mode selected (excluding Night mode and timer).
4. To adjust how the air purifier operates, follow the directions below.



NOTE

The replace filter icon will illuminate indicating that the filter needs to be replaced. To reset the indicator after the filter has been replaced, press and hold the  POWER button for 5 seconds.



SensAir™ LIVE PURITY CONTROL

- Your Breville Smart Air Plus™ Purifier has a built-in air quality sensor to detect changes to air quality in the surrounding area.
- The SensAir™ light around the control panel will change colours according to the quality of the surrounding air.
- The LED screen provides real-time indication of fine particles PM2.5 concentration.



Microbe Shield™/NIGHT MODE

The Microbe Shield™ and Night Modes utilise the same button on the control panel. Pressing the  Microbe Shield™/NIGHT button will cycle through these two settings.

Microbe Shield™

- Press the  Microbe Shield™/NIGHT mode button until the  Microbe Shield™ icon illuminates to turn it on.
- Press the button repeatedly until the light extinguishes to turn off this function.

Night Mode

- To turn on Night mode, press the  Microbe Shield™/NIGHT button repeatedly until the  icon starts to blink.
- Press again until the light extinguishes to turn off this function.
- After 10 blinks, all indicator lights on the control panel will turn off as the unit enters night mode and the fan speed will automatically change to Low.
- Press any button on the control panel to re-engage the control panel and turn off night mode. The  icon will extinguish.



NOTE

The Night mode function does not save for next use when the air purifier is switched off. This function will need to be reset.

FAN SPEED/TURBO MODE

NOTE



The air purifier will resume in the last programmed setting once it has been turned off, excluding Night mode, even if turned off at the power outlet.

- Press the  FAN SPEED button repeatedly until the desired speed is illuminated on the control panel.
- There are 4 fan speeds: Low, Medium, High and Turbo.
- The icons will illuminate showing the selected fan speed.

NOTE

When changing the fan speed, the unit may take a few seconds to adjust.

TIMER

- The air purifier can be set to operate for timed intervals of 2 hours, 4 hours and 12 hours, stopping automatically when the selected operating time has elapsed. If no timer is set, the air purifier will continuously operate until it is manually switched off.
- Press the  TIMER button repeatedly until the desired interval hours are illuminated on the control panel.
- For continuous operation, press the  TIMER button repeatedly until there are no lights illuminated under the timer intervals.

AUTO MODE

- When in Auto mode, the air purifier will automatically adjust the speed to help filter the air based on the sensor reading.
- To set to Auto, press the AUTO button until the Auto icon illuminates.
- Press the AUTO button again, to turn Auto off and Auto icon will extinguish.

IMPORTANT

Turning the unit On and Off will require cycling through the Auto mode.

CHILD LOCK

The air purifier control panel can be locked to inactivate the buttons.

1. To engage the child lock, press and hold the  CHILD LOCK button for 5 seconds.
2. To turn off, press and hold again for 5 seconds.

FILTER RESET

- The replace filter icon will illuminate indicating that the filter needs to be replaced.
- Replace the filter according to the directions found under Replacing the Filter in this book.
- Once the filter is replaced, press and hold the  POWER button for 5 seconds to reset the Filter Reset light.
- The built-in timer for the filter reset is 4,320 operating hours.

NOTE

For best performance, the filter should be cleaned at least monthly as per the instructions found in the Care, Cleaning & Storage section of this book.



Care, Cleaning & Storage

The air purifier and filter should be cleaned at least once every month. Ensure the air purifier is switched off and disconnected from the power outlet and allow all parts to cool before cleaning or storing.

- Use a clean, dry cloth to clean all external surfaces of the air purifier.



NOTE

More frequent cleaning may be required depending on environmental conditions.

BREVILLE RECOMMENDS

- Always ensure the air purifier is turned off, switched off at the power outlet and unplugged and allow the unit to cool before performing any cleaning or filter replacement.
- ✘ **DO NOT** stick any foreign objects or your fingers inside the air inlet/outlet of this unit.
- ✘ **DO NOT** use gasoline, benzene, thinner, harsh cleaners, etc. on and/or in the unit while cleaning as they will damage the unit.
- ✘ **NEVER** use alcohol or other solvents on this unit.

CLEANING THE SENSOR

- It is important to keep the air quality sensor clean for best performance.
- The air quality sensor is situated behind a grill at the rear of the unit.
- Gently vacuum the air quality sensor grill using a small hand brush tool. Cleaning should occur regularly, at least once a month.
- For more thorough cleaning, remove the cover by using the raised tab on the edge of the cover. Push inwards and outwards simultaneously to open the cover, noting that it will be tight.
- Gently vacuum the mesh filter and metal shield of the air quality sensor using the hand brush tool. Thorough cleaning should occur at least once every six months.
- Replace the mesh filter and cover when clean, ensuring it clicks into place.



WARNING

The air quality sensor is fragile and can be damaged if excessive force is used during cleaning. Please use extra care when cleaning.

FILTER CARE & CLEANING



WARNING

The filter is not washable. Do not immerse any part of the air purifier in water as it will cause damage.

- The Pre-filter should be cleaned at least once every month using a vacuum cleaner. Gently vacuum using a hand-tool attachment such as a brush or upholstery tool. Clean more often if required.
- Do not attempt to clean the carbon filter with a vacuum as this can cause damage.
- Do not use any solutions, hard bristle brushes or sharp objects to clean as this can cause damage.
- Replace the filter as indicated using the following instructions.

REPLACING THE FILTER

Your Smart Air Plus™ Purifier filter should be replaced in the time frames indicated below.

- The filter life is approximately 6 months if used 24 hours daily, or 12 months if used 12 hours daily.
 - The filter life may vary to this timing depending on environmental conditions.
 - Remove all packaging from the replacement filter and place the filter into the unit as described below.
1. Carefully, turn your air purifier upside down and remove the locking knob from the base of the unit.
 2. Remove the base plate.
 3. Remove the used filter, being careful that any residue or debris that may fall from the filter will not cause damage.
 4. Insert the replacement filter into the unit, ensuring that it is correctly fitted and centred.
 5. Replace the base plate and refasten the locking knob.
 6. Return the air purifier to an upright position.
 7. Turn on the air purifier then press and hold the  POWER button for 5 seconds to reset the Filter Reset light.



NOTE

There is no top or bottom on the filter. The filter can be placed into the unit either way.



NOTE

If the filter is not in place or not fitted correctly, the air purifier will not operate.



WARNING

Unintended use of the air purifier or damage to the housing may result in the escape of dangerous UV-C radiation which is dangerous to the eyes and skin. Never operate the UV-C light outside of the air purifier.



CARE OF UV-C LIGHT

The replacement of the UV-C light must be undertaken at an authorised Breville service centre. Please contact Breville Customer Service Centre for further support.

REPLACEMENT FILTERS

Replacement filters must be purchased from the Breville website[^] or at participating retail outlets.

See the table below for the replacement product code to suit this Breville Air Purifier.

Breville Air Purifier Model No.	Filter Replacement Product Code
the Easy Air™ LAP150WHT	LAP015WHT
the Smart Air™ LAP300WHT	LAP030WHT
the Smart Air Plus™ LAP500WHT	LAP050WHT

[^]Delivery charges may apply.

Please contact Breville Customer Service Centre for further support.

Only use the original Breville filter specially intended for this appliance. Do not use any other filters.



Troubleshooting

MINI TROUBLESHOOTING GUIDE

Before carrying out any of the following service checks, unplug the unit from the mains.

PROBLEM	WHAT TO DO
Unit will not start.	<ul style="list-style-type: none">• Check that the power plug is connected to a power outlet and the outlet is turned on.• Check that air purifier is assembled correctly.• Check that the filter is fitted correctly in place.
Insufficient air flow.	<ul style="list-style-type: none">• Check that the filters are clean.• Check for any obstructions in the air inlet and/or outlet.
Excessive noise.	<ul style="list-style-type: none">• Check for any foreign objects that may be in contact with the fan.• Check if the filter is clogged and ready for replacement.• Check that the air purifier has been assembled correctly and the locking knob has been tightened.• Check that the unit is on a level surface.
UV-C Light not illuminating	<ul style="list-style-type: none">• Contact Breville service centre for UV-C light replacement.



NOTE



NOTE

Breville Customer Service Centre

Australian Customers

Phone: 1300 139 798

Web: www.breville.com

New Zealand Customers

Phone: 0800 273 845

Web: www.breville.com

Breville®

Master Every Moment™

Breville, the Breville logo, Master Every Moment, Smart Air Plus, SensAir and the Microbe Shield logo are trademarks of Breville Pty. Ltd. A.B.N. 98 000 092 928.

Copyright Breville Pty. Ltd. 2019.

Due to continued product improvement, the products illustrated/photographed in this booklet may vary slightly from the actual product.

LAP500 ANZ D19