

Breville®

the Smart Grinder™ Pro

Instruction Booklet



Suits all BCG820 models

CONGRATULATIONS

on the purchase of your new
Breville product

CONTENTS

- 3** Breville recommends safety first
- 9** Know your Breville product
- 12** Operating your Breville product
- 20** Care, cleaning & storage
- 22** Coffee tips
- 24** Troubleshooting

At Breville we are very safety conscious. We design and manufacture consumer products with the safety of you, our valued customer, foremost in mind. In addition we ask that you exercise a degree of care when using any electrical appliance and adhere to the following precautions.

IMPORTANT SAFEGUARDS

FOR ALL ELECTRICAL APPLIANCES

- Remove and safely discard any packaging material and promotional labels before using the Breville Smart Grinder™ Pro for the first time.
- To eliminate a choking hazard for young children, remove and safely discard the protective cover fitted to the power plug of the Breville Smart Grinder™ Pro.
- Do not place the Breville Smart Grinder™ Pro near the edge of a bench or table during operation.
- Do not place the Breville Smart Grinder™ Pro on or near a hot gas burner, electric element or where it could touch a heated oven.
- Do not operate the Breville Smart Grinder™ Pro on a sink drain board.
- Ensure that the surface is level, clean and free of water.
- The Breville Smart Grinder™ Pro is not intended to be operated by means of an external timer or separate remote control system.
- To protect against electric shock, do not immerse the grinder base, power cord or power plug in water or allow moisture to come in contact with these parts.
- Always switch the Breville Smart Grinder™ Pro off at the power outlet and unplug if Breville Smart Grinder™ Pro is to be left unattended, if not in use, before cleaning, before attempting to move, disassembling, assembling and when storing.
- Do not use attachments other than those provided with the Breville Smart Grinder™ Pro.
- Do not operate the Breville Smart Grinder™ Pro without locking the bean hopper lid in position. Keep fingers, hands, hair, clothing and utensils away from the bean hopper during operation.

- The coffee grinder should not be switched on until the bean hopper and hopper lid are locked into position in the grinding chamber.
- Do not operate the Breville Smart Grinder™ Pro, continuously for longer than 2 minutes as this could cause overheating. Allow the Breville Smart Grinder™ Pro to cool down for 20 minutes after long operation.
- Do not use the Breville Smart Grinder™ Pro for any other purpose than grinding coffee beans.
- Do not use pre ground coffee in bean hopper. The Breville Smart Grinder™ Pro will not grind food that is sticky, or extremely hard, or make pastes of any fruits, seeds or herbs ie. curry pastes, nut butters.
- Keep the Breville Smart Grinder™ Pro and accessories clean. Follow the Care and Cleaning instructions provided on page 20.
- The installation of a residual current device (safety switch) is recommended to provide additional safety protection when using electrical appliances. It is advisable that a safety switch with a rated current not exceeding 30mA be installed in the electrical circuit supplying the appliance. See your electrician for professional advice.
- This appliance shall not be used by children. Keep the appliance and its cord out of reach of children.
- Appliances can be used by persons with reduced physical, sensory or mental capabilities or lack of experience and knowledge if they have been given supervision or instruction concerning use of the appliance in a safe way and if they understand the hazards involved.
- Children should be supervised to ensure that they do not play with the appliance.

IMPORTANT SAFEGUARDS FOR ALL ELECTRICAL APPLIANCES

- Unwind the power cord fully before use.
- Do not let the power cord hang over the edge of a bench or table or, touch hot surfaces or become knotted.
- To protect against electric shock, do not immerse the appliance, power cord or power plug in water or any other liquid.
- It is recommended to regularly inspect the appliance. Do not use the appliance if the power cord, power plug or appliance becomes damaged in any way. Return the entire appliance to the nearest authorised Breville Service Centre for examination and/or repair.
- Any maintenance, other than cleaning, should be performed at an authorised Breville Service Centre.
- This appliance is for household use only. Do not use this appliance for anything other than its intended use. Do not use in moving vehicles or boats. Do not use outdoors. Misuse may cause injury.
- The installation of a residual current device (safety switch) is recommended to provide additional safety protection when using electrical appliances. It is advisable that a safety switch with a rated residual operating current not exceeding 30mA be installed in the electrical circuit supplying the appliance. See your electrician for professional advice.
- The appliance is not intended to be operated by means of an external timer or separate remote control system.
- Connect only to a 220-240V power outlet.

SAVE THESE INSTRUCTIONS FOR HOUSEHOLD USE ONLY

KNOW

your Breville product

KNOW YOUR BREVILLE PRODUCT

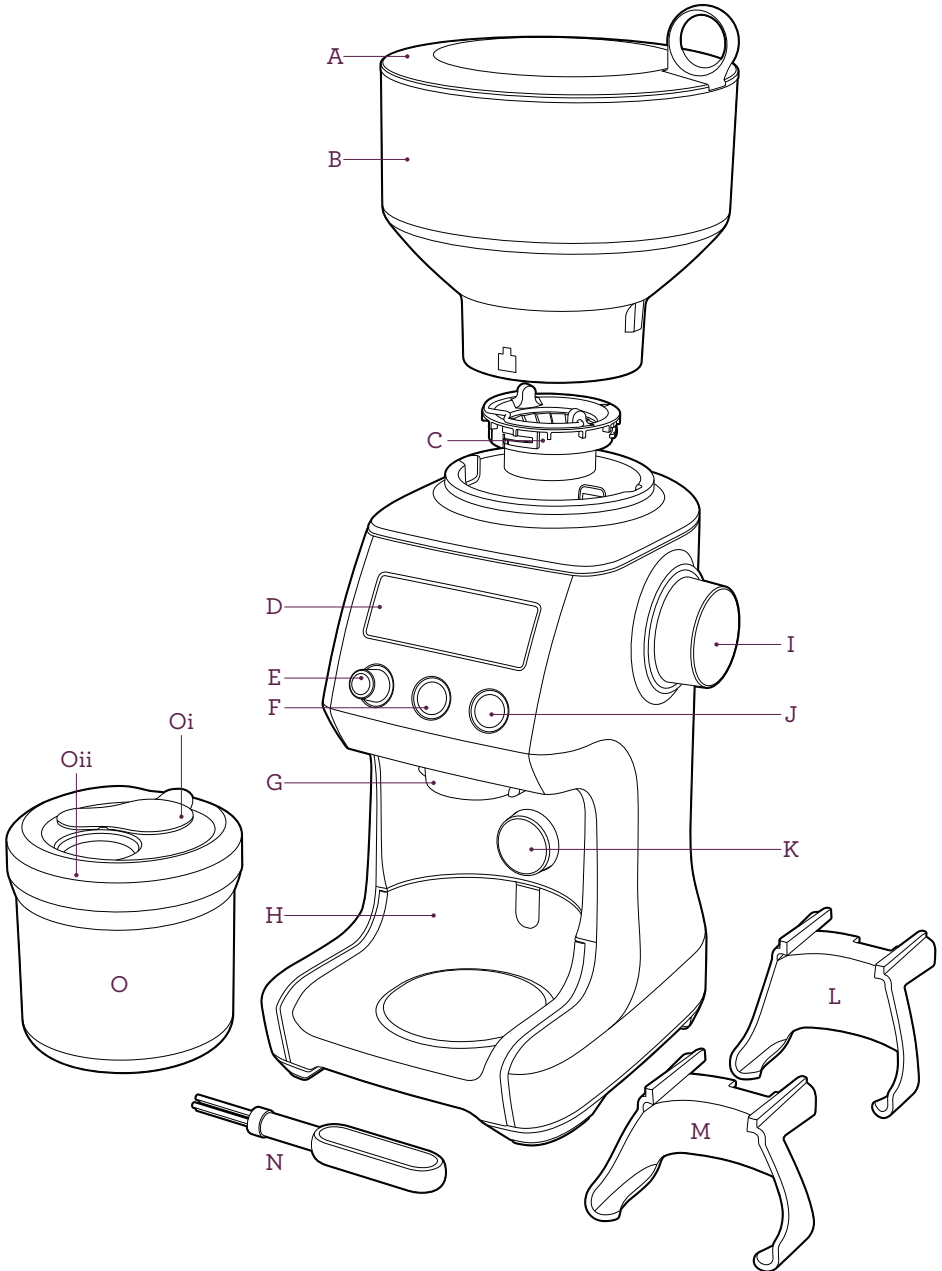

KNOW YOUR BREVILLE PRODUCT

- A. **Bean Hopper Lid**
Air tight seal to maximise bean freshness.
- B. **Bean Hopper**
450g bean hopper with locking system for easy removal and bean transfer.
- C. **Hardened Stainless Steel Conical Burrs**
Maximises particle size for full flavour potential.
- **Removable and Adjustable Upper Burr**
- D. **Backlit LCD Screen**
Displays grind setting, grind size, number of shots or cups and current grind time.
- E. **GRIND AMOUNT|PROGRAM Dial**
Adjusts programmed amount to increase or decrease dose.
- F. **SHOTS|CUPS Button**
Selects number of shots or cups.
- G. **Grind Outlet**
- H. **Grind Tray**
Catches grind overflow.
Removable for easy cleaning.
- I. **Grind Size Dial**
60 custom grind settings from espresso to plunger.
- J. **START|PAUSE|CANCEL Button**
Starts, Pauses and Cancels operation.
- K. **Portafilter Activation Switch**
Activates or cancels grinder with a press of the portafilter.

ACCESSORIES

- L. **Portafilter Cradle 50–54mm**
- M. **Portafilter Cradle 58mm**
- N. **Conical Burr Cleaning Brush**
- O. **Grinds Container**
For storing ground coffee.
Oi - Container Cap
Oii - Container Lid

NOT SHOWN

Grinding Chamber

Minimises static of beans before dispensing.

Automatic Thermal Safety Shut Off

Protects motor from overheating.

Power Saving/Sleep Mode

Unit powers down to standby after 5 minutes of non use.

Cord Storage

OPERATING

your Breville product

GRINDER OVERVIEW

Your Smart Grinder™ Pro uses Hardened Stainless Steel Conical Burrs and is able to grind whole bean coffee suitable for a range of Brewing Methods, from the finest setting for Espresso to the coarsest setting for Plunger. You are able to select the amount of Shots or Cups with a single button. The Grind Amount (dose) for all coffee types is controlled by a digital timer. The default dose for each Brew Method is able to be adjusted by simply turning the Grind Amount dial and changing the time the grinder will run. Once you have your desired dose, you can press and hold the PROGRAM button to set your custom time. You can grind directly into a Portafilter, Grinds Container or Drip Coffee filter basket.

BEFORE FIRST USE

Before first use, remove and safely discard all promotional labels and packing materials attached to your Breville product. Wash hopper, cradles, grind container, container lid and cleaning brush in warm soapy water and dry thoroughly. Wipe exterior of grinder with a soft damp cloth and dry thoroughly. Place grinder on flat level surface and plug power cord into 230-240V outlet and switch Power 'ON'.

ENERGY SAVING FEATURE

The grinder will automatically switch off if not used after 5 minutes.

To reactivate the machine whilst in POWER SAVING/SLEEP MODE, press any button on the grinder control panel.

NOTE

If bean hopper has not been locked into position, 'PLEASE LOCK HOPPER' message will be displayed on the LCD screen disabling the operation of the grinder for safety.

ASSEMBLING YOUR BREVILLE SMART GRINDER™ PRO

Bean Hopper

Align tabs on the base of the bean hopper and insert hopper into position. Turn the bean hopper dial 90° to lock into position. Fill with fresh coffee beans and secure lid on top of bean hopper.

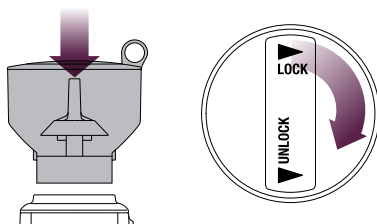

The bean hopper can be removed by turning dial anti clockwise and lifting hopper to pull out. The locking system allows you to remove and transfer beans in the hopper to a storage container safely.

Within each Brew Method, Espresso, Percolator, Filter or Plunger, there is a range of grind size settings. Between each Brew Method the grind size settings will differ. This is due to each method requiring different grind sizes for optimum extraction.

Experiment with different grind size settings by rotating the Grind Size dial to achieve the brew that best suits your taste.

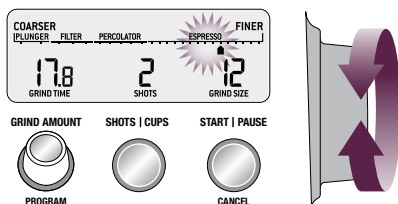

OPERATING YOUR BREVILLE PRODUCT

Grinding for Espresso Coffee

Use single wall filter baskets when grinding fresh coffee beans. Use the finer 1-30 settings in the ESPRESSO range.

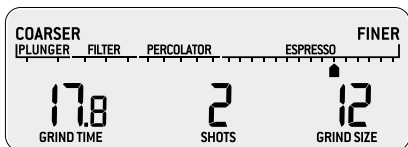

STEP 1:

Insert the appropriate Portafilter Cradle size. Insert your portafilter into the cradle.

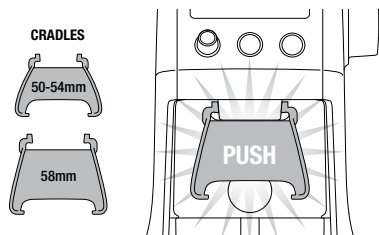

NOTE

You can change the amount already selected during operation by pressing the SHOTS|CUPS button. Maximum number of shots with the cradle inserted is 2.

STEP 2:

Selecting your SHOTS|CUPS

Select the desired amount of ground coffee required by pressing the SHOTS|CUPS button.

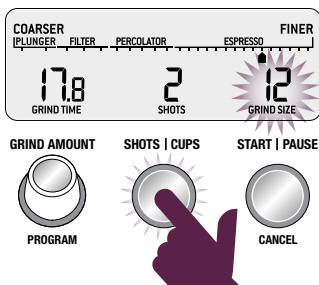

Continue pressing the SHOTS|CUPS button until desired amount is displayed.

The maximum number of shots or cups for each Brew Method is shown in the Coffee Chart below. The amount dispensed will vary depending on the Brew Method selected and the Grind Amount.

Rotate the Grind Amount dial to adjust the grinding time to achieve the correct amount of coffee. Increasing time will increase the dose and decreasing the time will decrease the dose.

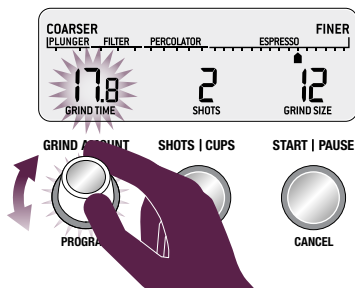

COFFEE CHART

| BREW METHOD | ESPRESSO | PERCOLATOR | DRIP FILTER | PLUNGER |
|---------------|-----------------|-----------------|-----------------|-----------------|
| GRIND SETTING | FINE | MEDIUM | MEDIUM COARSE | COARSE |
| GRIND SIZE | 1-30 | 31-45 | 46-54 | 55-60 |
| AMOUNT | 1 UP TO 8 SHOTS | 1 UP TO 12 CUPS | 1 UP TO 12 CUPS | 1 UP TO 12 CUPS |

OPERATING YOUR BREVILLE PRODUCT

STEP 3:

Select your Grind Size

For espresso, we recommend selecting Grind Size setting 12 as a starting point and moving the Grind Size dial Coarser or Finer to adjust the flow of espresso as required. This should be done in conjunction with setting the Grind Amount (dose).

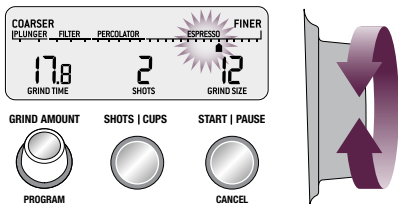

You will need to extract a shot of espresso to determine if a change in Grind Size and/or Grind Amount is necessary to achieve the correct rate of flow. Traditionally, a single shot of espresso is defined as ~30ml in 30 seconds and a double shot of espresso as ~60mls in 30 seconds.

NOTE

If the Grind Size dial is tight, run the grinder by pressing the **START|PAUSE|CANCEL** button while turning the Grind Size dial. This will release coffee grounds caught between the burrs.

Grinding into Grinds Container or Coffee Filter

STEP 1:

Remove cradle by sliding out from under the grind outlet.

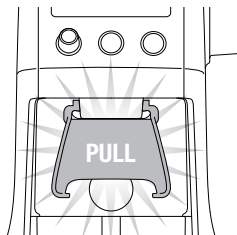

Slide in Grinds Container with cap open or Coffee Filter directly under grind outlet.

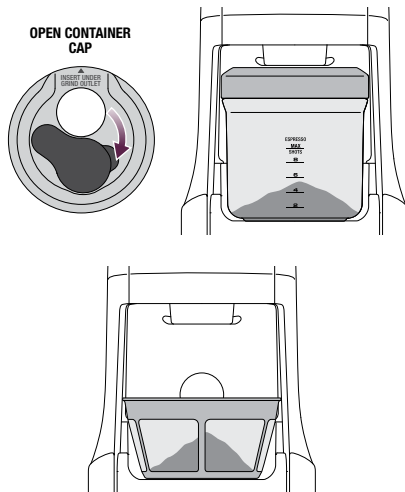

- Select the required amount of ground coffee by pressing the **SHOTS|CUPS** button.

OPERATING YOUR BREVILLE PRODUCT

- Press the START|PAUSE|CANCEL button to start grinding operation.

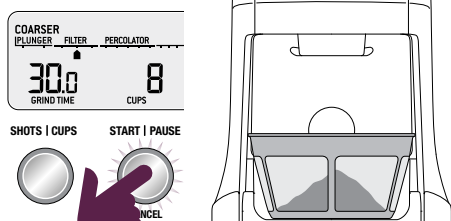
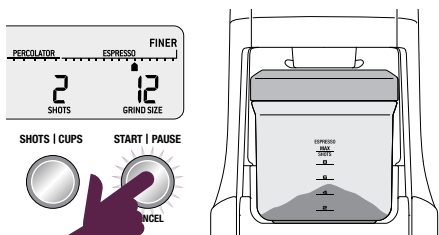

You can grind into Grinds Container without the lid. However, we recommend keeping the lid on to prevent coffee grinds from escaping.

FEATURES OF YOUR BREVILLE SMART GRINDER™ PRO

Automatic Grinding

Grinding automatically allows you to grind hands-free. The grinder will automatically stop when the preset amount of coffee is dispensed.

- 'Press & Release' either the START|PAUSE|CANCEL button or push the handle of your portafilter once. This will activate the PORTAFILTER SWITCH.
- Grinding will automatically stop when the preset amount is dispensed.

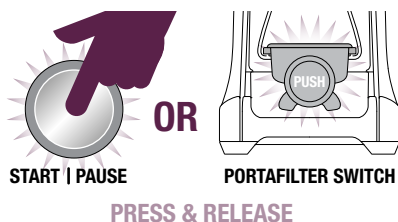

It is normal for the correct amount of coffee to appear overfilled in your portafilter. Untamped coffee is approximately three times the volume of tamped coffee.

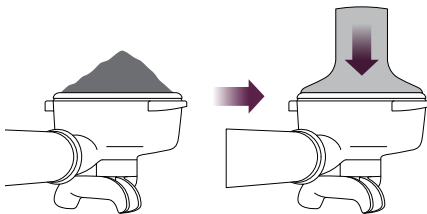

NOTE

Programming a custom grind amount/time sets it for just that Brew Method. This will not change the other Shots or Cups settings.

Pause Function

You can pause the grinder during operation allowing you to collapse or settle the coffee in the portafilter.

- ‘Press & Release’ the START|PAUSE|CANCEL button to start the grinding operation.
- During grinding, press the START|PAUSE|CANCEL button again to pause the operation for 10 seconds.
- Press again within this time to resume the balance of the dose.

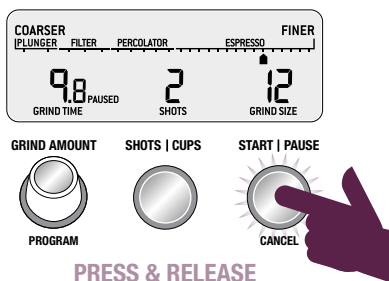

Manual Grinding

Grinding manually allows you to have complete control over how much coffee is dispensed.

- ‘Press & Hold’ either the START|PAUSE|CANCEL button or push the handle of your portafilter to activate the PORTAFILTER SWITCH for as long as you require.
- ‘Release’ START|PAUSE|CANCEL button or PORTAFILTER SWITCH and grinding will stop.

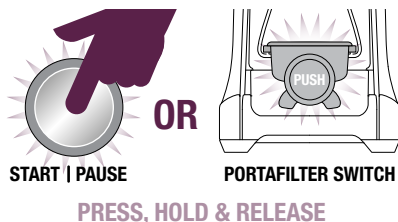

Program Function

Once you have set your required dose, you can program this time into the number of shot(s) currently displayed on the LCD. Press and hold the PROGRAM button, grinder will beep twice to confirm. Only the shot displayed will be programmed, all other shots will remain unchanged.

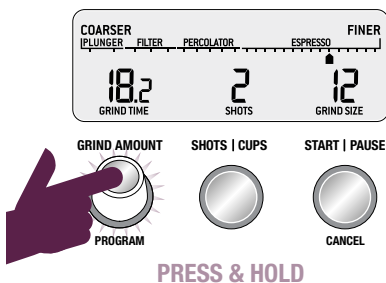

ADJUSTING YOUR GRIND AMOUNT

The GRIND AMOUNT dial gives you the ability to modify the preset SHOTS|CUPS amounts to deliver more or less ground coffee into your Portafilter or Grinds Container.

Increasing the Grind Amount

To increase the grind amount selected, turn the GRIND AMOUNT dial to the right.

Each adjustment will increase the grind time by 0.2 of a second.

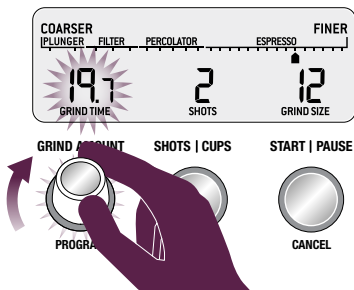

Decreasing the Grind Amount

To decrease grind amount selected, turn the GRIND AMOUNT dial to the left.

Each adjustment will decrease the grind time by 0.2 of a second.

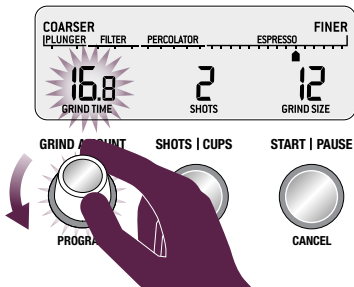

NOTE

To RESET the grind amount/time to the default settings, 'press & hold' the SHOTS|CUPS button until a long beep sounds.

ADJUSTING CONICAL BURRS

Some types of coffee may require a wider grind range to achieve an ideal extraction or brew. A feature of your Smart Grinder™ Pro is the ability to extend this range with an adjustable upper burr. We recommend making only one adjustment at a time.

- 

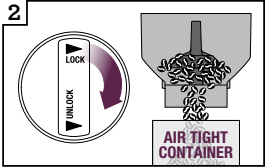
1
Unlock hopper
- 

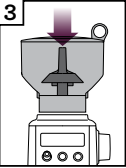
2
Hold hopper over container & turn dial to release beans into container
- 

3
Align hopper into position
- 

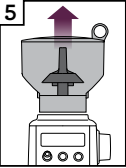
4
Run grinder until empty
- 

5
Remove hopper
- 

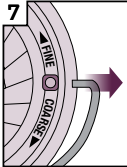
6
Remove upper burr
- 

7
Remove wire handle from both sides of the burr
- 

8
Move adjustable top burr, 1 number coarser or finer
- 

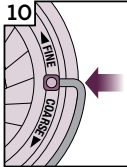
9
Align the number with the handle opening
- 

10
Insert wire handle from both sides of the burr
- 

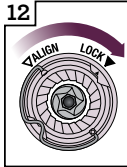
11
Push upper burr firmly into position
- 

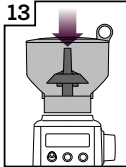
12
Lock upper burr
- 

13
Align hopper into position
- 

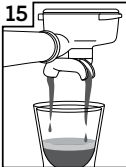
14
Lock hopper
- 

15
Check your extraction

CARE, CLEANING & STORAGE

CARE, CLEANING & STORAGE

CARE, CLEANING & STORAGE

1. Empty beans from the hopper and grind out any excess beans (see below).
2. Unplug power cord from power outlet before cleaning.
3. Wash the grind container and lid, bean hopper and lid in warm soapy water, rinse and dry thoroughly.
4. Wipe and polish exterior of appliance with a soft damp cloth.

NOTE

Do not use alkaline or abrasive cleaning agents, steel wool or scouring pads, as these can damage the surface.

NOTE

We recommend you do not clean any grinder parts or accessories in the dishwasher.

CLEANING CONICAL BURRS

Regular cleaning helps the burrs achieve consistent grinding results which is especially important when grinding for espresso coffee.

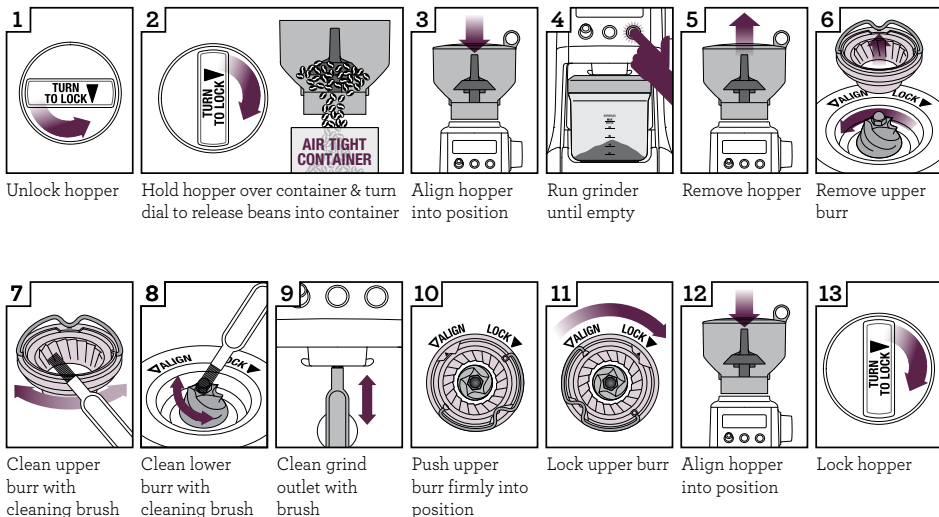

COFFEE TIPS

MAKING BETTER QUALITY COFFEE

- Freshly ground coffee is the key to making coffee with more flavour and body.
- Coffee flavour and strength is a personal preference. Vary the type of coffee beans, amount of coffee and fineness of grind to achieve the flavour you prefer.
- Use freshly roasted coffee beans with a 'roasted on' date to maximise flavour, not a use-by or best before date.
- Use coffee beans between 5 and 20 days after the 'roasted on' date for optimal freshness.
- Store coffee beans in a dark, cool and dry place. Vacuum seal if possible.
- Buy in small batches to reduce the storage time and store no more than one week's supply at any time.
- Once coffee is ground, it quickly loses its flavour and aroma. For the best results, grind beans immediately before brewing.
- Do not store beans in the bean hopper. Place them back in an airtight container.
- When storing the appliance, run grinder empty to clear ground beans left in chamber.
- Run grinder for 2 seconds to purge some coffee before each use, for maximum freshness.
- Clean the bean hopper and conical burrs regularly.

PLUNGER COFFEE

Follow these easy steps for a great cup:

1. Using a variable temperature kettle, heat the appropriate volume of water to 95°C. This is an ideal temperature for brewing coffee. Never using boiling water.
2. Select Grind Size setting 58.
3. Select the number of cups you are brewing. Adjust the amount of coffee to suit the strength you prefer.
4. Place the ground coffee in the plunger vessel.
5. Pour the heated water into the plunger in a swirling manner to ensure all the ground coffee is soaked & the plunger vessel is full. The 'bloom' (expanding coffee & gases) should reach the top of the plunger.
6. Using a timer, wait 4 minutes.
7. Using a spoon, break the 'crust' (the bloom becomes dense & a bit hard).
8. Insert the plunger & carefully press down.
9. Do not press too hard. Gently release pressure by pulling up slightly and press down again if you have pressed too hard.

TROUBLESHOOTING

TROUBLESHOOTING

| PROBLEM | POSSIBLE CAUSE | WHAT TO DO |
|--|---|--|
| Grinder does not start after pressing START PAUSE CANCEL button | <ul style="list-style-type: none"> Grinder not plugged in. Grinder has overheated. Bean hopper not attached correctly. 'PLEASE LOCK HOPPER' will be displayed on LCD screen. | <ul style="list-style-type: none"> Plug power cord into power outlet. Remove power plug from power outlet. Leave for 20 minutes to cool down before using again. Lock bean hopper into position. |
| Motor starts but no ground coffee coming from grind outlet | <ul style="list-style-type: none"> Incorrect button press. No coffee beans in bean hopper. Grinder/bean hopper is blocked. | <ul style="list-style-type: none"> Press START PAUSE CANCEL or PORTAFILTER SWITCH to activate. Fill bean hopper with fresh coffee beans. Remove bean hopper. Inspect bean hopper & burrs for blockage. Replace parts and try again. |
| Motor starts but operates with a loud 'racket' noise | <ul style="list-style-type: none"> Grinder is blocked with foreign item or chute is blocked. Moisture clogging grinder. | <ul style="list-style-type: none"> Remove bean hopper, inspect burrs & remove any foreign body. Clean burrs and chute (refer to Care & Cleaning on page 20). Leave burrs to dry thoroughly before re-assembling. It is possible to use a hair dryer to blow air into grinder inlet (lower burr) to dry. |
| Unable to lock bean hopper into position | <ul style="list-style-type: none"> Coffee beans obstructing bean hopper locking device. | <ul style="list-style-type: none"> Remove bean hopper. Clear coffee beans from top of burrs. Re-lock hopper into position & try again. |
| Not enough/ too much coffee grind | <ul style="list-style-type: none"> Grind amount requires adjustment. | <ul style="list-style-type: none"> Press SHOTS CUPS button to change grind amount. Use GRIND AMOUNT dial to fine tune the amount 'more' or 'less'. |
| Portafilter overfills | | <ul style="list-style-type: none"> It is normal for the correct amount of coffee to appear overfilled in your portafilter. Untamped coffee has approximately three times the volume of tamped coffee. |
| Emergency stop? | | <ul style="list-style-type: none"> Press START PAUSE CANCEL button to stop operation. Unplug power cord from power outlet. |

Breville®

Breville Customer Service Centre

Australian Customers

Mail: PO Box 22
Botany NSW 2019
AUSTRALIA

Phone: 1300 139 798

Fax: (02) 9384 9601

Email: Customer Service:
askus@breville.com.au

New Zealand Customers

Mail: Private Bag 94411
Botany Manukau 2163
Auckland NEW ZEALAND

Phone: 0800 273 845

Fax: 0800 288 513

Email: Customer Service:
askus@breville.com.au

www.breville.com.au

Breville is a registered trademark of Breville Pty. Ltd. A.B.N. 98 000 092 928.
Copyright Breville Pty. Ltd. 2013.

Due to continued product improvement, the products illustrated/photographed
in this brochure may vary slightly from the actual product.